

# 0.4mm Pitch

# Series 5805

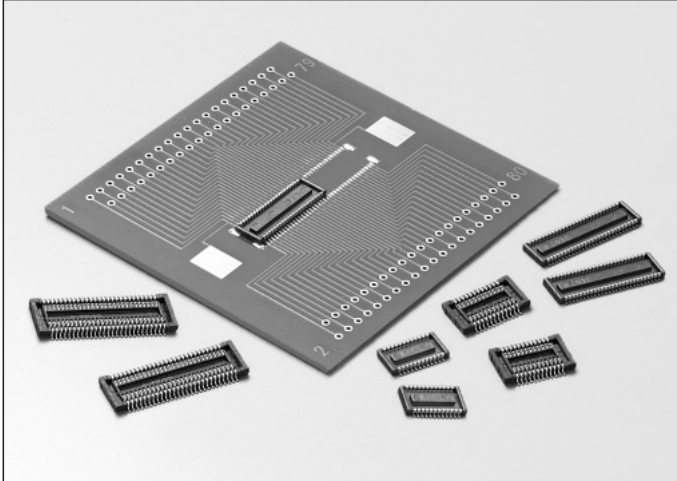

シリーズ (Series)	5805
基板間高さ (Stacking Height)	1.0mm
極間隔 (Pitch)	0.4mm
極数 (No. of Positions)	10~80
定格電流 (Rated Current)	AC/DC 0.3A
定格電圧 (Rated Voltage)	AC/DC 50V
耐電圧 (D.W.Voltage)	AC 250Vrms/min.
コンタクト材質 (Contact Material)	銅合金 Copper alloy
インシュレータ材質 (Insulator Material)	耐熱樹脂 Heat resistance plastic
使用温度範囲 (Operating Temperature)	-40~85℃

## SERIES 5805

### ◇概要

5805シリーズは、市場における携帯電話、PHS、デジタルAV機器の小型化、薄型化の要求に基づき開発された、0.4mmピッチの超低背基板対基板コネクタです。基板間高さ1.0mm、端子を含めた幅寸法は5.0mmを実現しました。

### ◇Outline

Series 5805 is a 0.4mm pitch Board to Board connector to meet the market requirement for downsizing and thinner tendency in cellular phones, PHS, and Digital AV apparatus. 1.0mm in stacking height and 5.0mm in width including tails are realized.

### ◇特長

- (1) バネ構造に弊社独自の「S字状ばね」を採用。嵌合高さH=1.0mmの低背化を実現しました。
- (2) スリム・低背でありながらコネクタ裏面は底壁が形成されており金属の露出がなくデッドスペースが小さいことから、端子のランド対向間にパターン配線が可能であり、高密度実装に最適な構造です。
- (3) 高い接触信頼性を実現するために、接触構造は振動や落下衝撃に強い挟み込み構造を採用するとともに、接触部は飛散したフラックスや付着した異物を排除する独自接点構造を採用しました。
- (4) 嵌合構造は「FINE-LOCK構造」を採用し、超低背と優れたクリック感・高い嵌合保持力との両立を実現しました。
- (5) 実装工程で使用いただけるチェッカー専用コネクタもご用意しました。

### ◇Features

- (1) KEC-unique S-shaped spring is adopted for the spring structure, which realizes 1.0mm in stacking height.
- (2) Because no part of pins were exposed owing to the bottom wall of the connector in spite of its slim and low profile, a pattern can be laid between lands of tail rows, which enables less limited pattern layouts on boards.
- (3) The pinching structure, highly resistant to vibration and drop shock, is adopted in contacts and the original structure excluding splashed flux or foreign matters attached is adopted on contacting points in order to obtain high contacting reliability.
- (4) "Fine locking mechanism" adopted for mating structure realizes the nice clicking response and firm retention force against unmating despite of the ultra low profile.
- (5) A checker connector to be mated with a connector is also available to check electrical continuity or short circuit of the connector.

本カタログには推奨めっきを掲載しております。めっき種類・仕様、ならびに生産対応可能極数については営業部に御確認願います。  
Recommended plating types are mentioned in this catalogue.  
For other plating types and their specifications, and available numbers of positions, please feel free to contact our sales department.

0.4mm Pitch  
SERIES

# 5805

プラグ/リセ ST SMT  
Plug/Receptacle Vertical SMT

## ● Plug

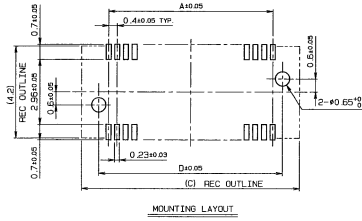
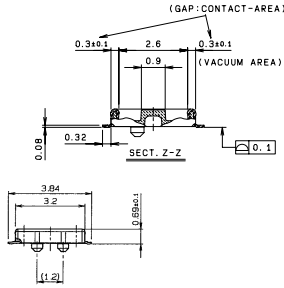
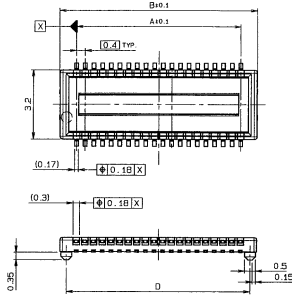

極数 NO. OF POS.	A	B	C	D
10	1.6	3.14	4.1	2.5
16	2.8	4.34	5.3	3.7
20	3.6	5.14	6.1	4.5
24	4.4	5.94	6.9	5.3
26	4.8	6.34	7.3	5.7
30	5.6	7.14	8.1	6.5
34	6.4	7.94	8.9	7.3
40	7.6	9.14	10.1	8.5
44	8.4	9.94	10.9	9.3
50	9.6	11.14	12.1	10.5
54	10.4	11.94	12.9	11.3
60	11.6	13.14	14.1	12.5
64	12.4	13.94	14.9	13.3
70	13.6	15.14	16.1	14.5
80	15.6	17.14	18.1	16.5

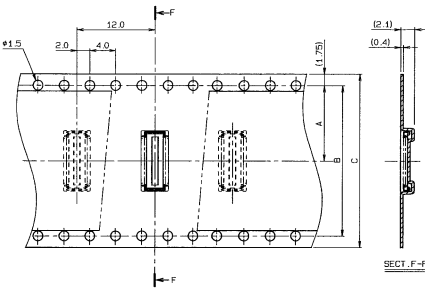

極数 NO. OF POS.	A	B	C
10	5.5	-	12
16	7.5	-	16
20	7.5	-	16
24	7.5	-	16
26	7.5	-	16
30	7.5	-	16
34	11.5	-	24
40	11.5	-	24
44	11.5	-	24
50	11.5	-	24
54	11.5	-	24
60	11.5	-	24
64	11.5	-	24
70	11.5	-	24
80	14.2	28.4	32

注文コード ORDERING CODE  
**14 5805 XXX 00X 829+**

RoHS対応品  
RoHS Compliant Product

- 0: 金具無し・ボス無し  
Without metal tab or boss
- 1: 金具無し・ボス有り  
Without metal tab, With boss

極数 Number of positions

注) 生産可能極数については営業部にご確認願います。  
Note) Feel free to contact our sales department for available numbers of positions.

梱包数量: 2000個/リール  
PACKING QUANTITY: 2000/Reel

## ● Receptacle

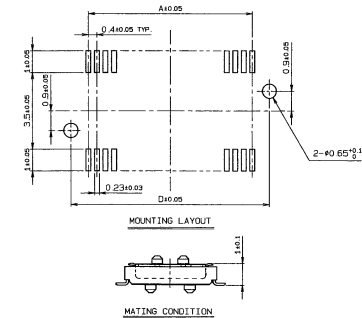
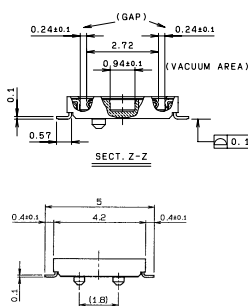
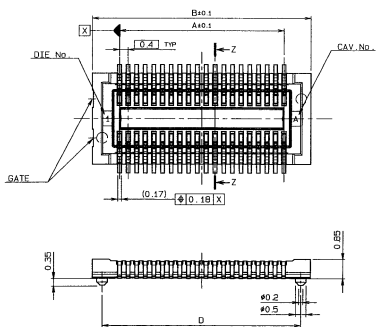

極数 NO. OF POS.	A	B	D
10	1.6	4.1	3.2
16	2.8	5.3	4.4
20	3.6	6.1	5.2
24	4.4	6.9	6.0
26	4.8	7.3	6.4
30	5.6	8.1	7.2
34	6.4	8.9	8.0
40	7.6	10.1	9.2
44	8.4	10.9	10.0
50	9.6	12.1	11.2
54	10.4	12.9	12.0
60	11.6	14.1	13.2
64	12.4	14.9	14.0
70	13.6	16.1	15.2
80	15.6	18.1	17.2

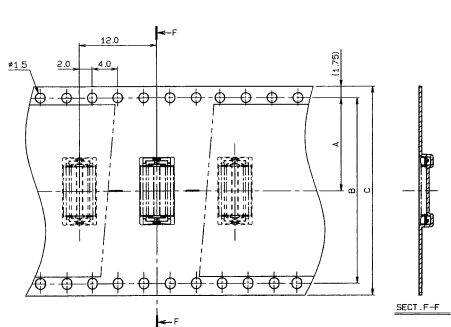

極数 NO. OF POS.	A	B	C
10	5.5	-	12
16	7.5	-	16
20	7.5	-	16
24	7.5	-	16
26	7.5	-	16
30	7.5	-	16
34	11.5	-	24
40	11.5	-	24
44	11.5	-	24
50	11.5	-	24
54	11.5	-	24
60	11.5	-	24
64	11.5	-	24
70	11.5	-	24
80	14.2	28.4	32

注文コード ORDERING CODE  
**24 5805 XXX 00X 829+**

RoHS対応品  
RoHS Compliant Product

- 0: 金具無し・ボス無し  
Without metal tab or boss
- 1: 金具無し・ボス有り  
Without metal tab, With boss

極数 Number of positions

注) 生産可能極数については営業部にご確認願います。  
Note) Feel free to contact our sales department for available numbers of positions.

梱包数量: 2000個/リール  
PACKING QUANTITY: 2000/Reel