

1.5 MHz, 600mA Synchronous Step-Down Converter

GENERAL DESCRIPTION

The APS1006 is a 1.5MHz constant frequency, slope compensated current mode PWM step-down converter. The device integrates a main switch and a synchronous rectifier for high efficiency without an external Schottky diode. It is ideal for powering portable equipment that runs from a single cell lithium-Ion (Li+) battery. The APS1006 can supply 600mA of load current from a 2.5V to 5.5V input voltage. The output voltage can be regulated as low as 0.6V. The APS1006 can also run at 100% duty cycle for low dropout operation, extending battery life in portable system. Pulse Skipping Mode operation at light loads provides very low output ripple voltage for noise sensitive applications.

The APS1006 is offered in a low profile (1mm) 5-pin, SOT package, and is available in an adjustable version and fixed output voltage of 1.2V, 1.5V and 1.8V.

APPLICATIONS

- Cellular and Smart Phones
- Microprocessors and DSP Core Supplies
- Wireless and DSL Modems
- PDAs
- MP3 Player
- Digital Still and Video Cameras
- Portable Instruments

FEATURES

- High Efficiency: Up to 96%
- 1.5MHz Constant Switching Frequency
- 600mA Output Current at $V_{IN}=3V$
- Integrated Main switch and synchronous rectifier. No Schottky Diode Required
- 2.5V to 5.5V Input Voltage Range
- Output Voltage as Low as 0.6V
- 100% Duty Cycle in Dropout
- Low Quiescent Current: 300 μ A
- Slope Compensated Current Mode Control for Excellent Line and Load Transient Response
- Short Circuit Protection
- Thermal Fault Protection
- <1 μ A Shutdown Current
- Space Saving 5-Pin Thin SOT23 package

EVALUATION BOARD

Standard Demo Board	Dimensions (mm)
EV1006ET5-02	60X x 60Y x 1.6Z

Typical Application

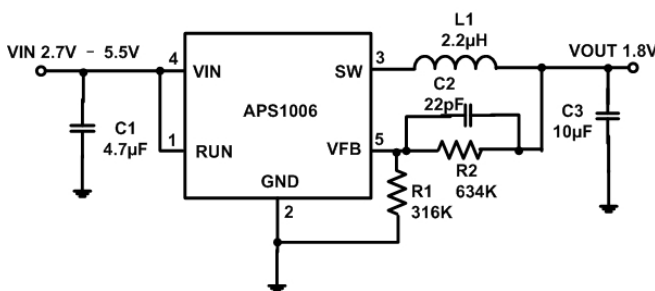
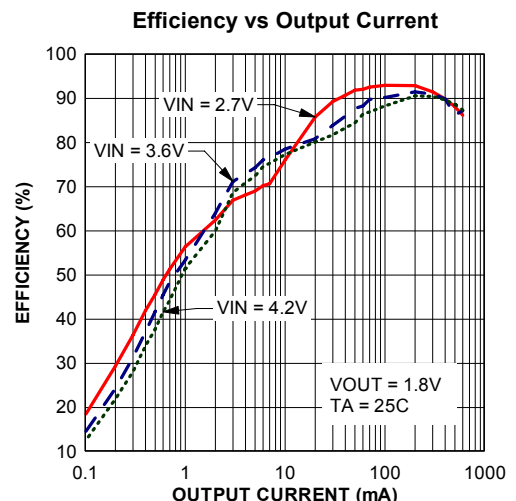

Figure 1. Basic Application Circuit with APS1006 adjustable version, $V_{out} = 1.8V$



Absolute Maximum Rating ^(Note 1)

Input Supply Voltage -0.3V to +6V
 RUN, V_{FB} Voltages -0.3V to V_{IN}+0.3V
 SW, V_{out} Voltages -0.3V to V_{IN}+0.3V
 Peak SW Sink and Source Current..... 1.5A

Operating Temperature Range... -40°C to +85°C
 Junction Temperature ^(Note2) +125°C
 Storage Temperature Range -65°C to +150°C
 Lead Temperature (Soldering, 10s)..... +300°C

Package/Order Information

Adjustable Output Version:

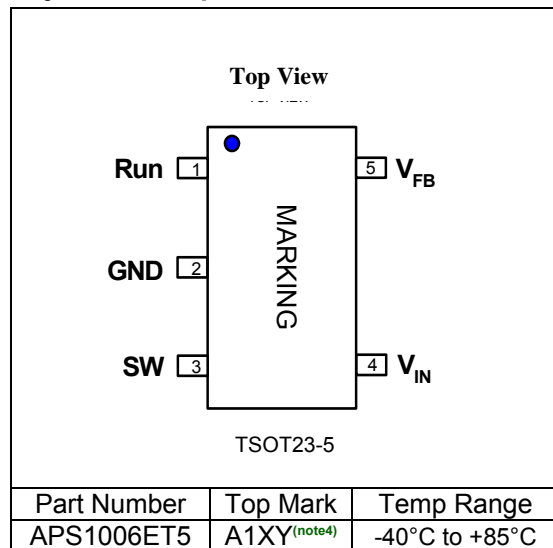

Fixed Output Versions:

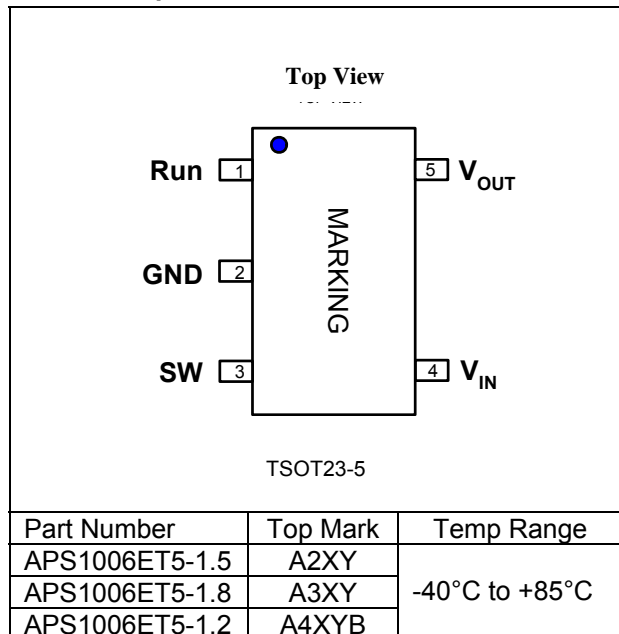

Thermal Resistance ^(Note 3):

Package	Θ_{JA}	Θ_{JC}
TSOT23-5	250°C/W	110°C/W

Note 1: Absolute Maximum Ratings are those values beyond which the life of a device may be impaired.

Note 2: T_J is calculated from the ambient temperature T_A and power dissipation P_D according to the following formula:

$$T_J = T_A + P_D \times \Theta_{JA}$$

Note 3: Thermal Resistance is specified with approximately 1 square of 1 oz copper.

Note 4: XY = Manufacturing Date Code

Electrical Characteristics (Note 5)

($V_{IN}=V_{RUN}=3.6V$, $T_A=25^{\circ}C$, Test Circuit Figure 1, unless otherwise noted.)

Parameter	Conditions	MIN	TYP	MAX	unit
Input Voltage Range		2.5		5.5	V
Input DC Supply Current					
Active Mode	$V_{FB}=0.5V$		270	400	μA
Shutdown Mode	$V_{FB}=0V$, $V_{IN}=4.2V$		0.08	1.0	μA
Regulated Feedback Voltage	$T_A = +25^{\circ}C$	0.5880	0.6000	0.6120	V
	$T_A = 0^{\circ}C \leq T_A \leq 85^{\circ}C$	0.5865	0.6000	0.6135	V
	$T_A = -40^{\circ}C \leq T_A \leq 85^{\circ}C$	0.5850	0.6000	0.6150	V
V_{FB} Input Bias Current	$V_{FB} = 0.65V$			± 30	nA
Reference Voltage Line Regulation	$V_{IN} = 2.5V$ to $5.5V$, $V_{OUT} = V_{FB}$ ($R2=0$)		0.11	0.40	%/V
Regulated Output Voltage	APS1006ET5-1.2, $-40^{\circ}C \leq T_A \leq 85^{\circ}C$	1.164	1.200	1.236	V
	APS1006ET5-1.5, $-40^{\circ}C \leq T_A \leq 85^{\circ}C$	1.455	1.500	1.545	V
	APS1006ET5-1.8, $-40^{\circ}C \leq T_A \leq 85^{\circ}C$	1.746	1.800	1.854	V
Output Voltage Line Regulation	$V_{IN} = 2.5V$ to $5.5V$, $I_{OUT}=10mA$		0.11	0.40	%/V
Output Voltage Load Regulation	I_{OUT} from 10 to 600mA		0.0015		%/mA
Maximum Output Current	$V_{IN} = 3.0V$	600			mA
Oscillator Frequency	$V_{FB}=0.6V$ or $V_{OUT}=100\%$	1.2	1.5	1.8	MHz
$R_{DS(ON)}$ of P-CH MOSFET	$I_{SW} = 300mA$		0.30	0.50	Ω
$R_{DS(ON)}$ of N-CH MOSFET	$I_{SW} = -300mA$		0.20	0.45	Ω
Peak Inductor Current	$V_{IN}=3V$, $V_{FB}=0.5V$ or $V_{OUT}=90\%$ Duty Cycle <35%		1.20		A
SW Leakage	$V_{RUN} = 0V$, $V_{SW}= 0V$ or $5V$, $V_{IN} = 5V$		± 0.01	± 1	μA
Output over voltage lockout	$\Delta V_{OVL} = V_{OVL} - V_{FB}$		60		mV
RUN Threshold	$-40^{\circ}C \leq T_A \leq 85^{\circ}C$	0.3	0.45	1.5	V
RUN Leakage Current			± 0.1	± 1	μA

Note 5: 100% production test at $+25^{\circ}C$. Specifications over the temperature range are guaranteed by design and characterization.

Typical Performance Characteristics

(Test Figure 1 above unless otherwise specified)

Efficiency vs Input Voltage

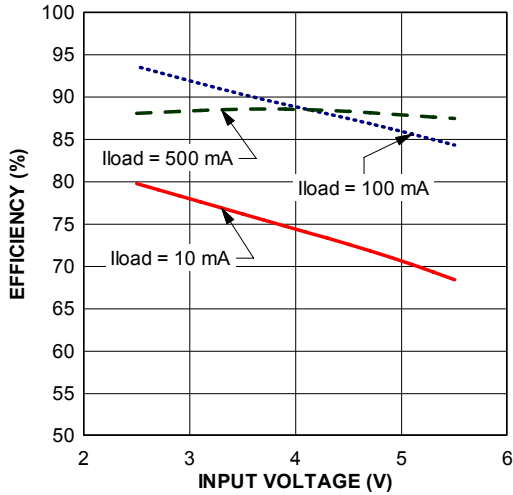

Efficiency vs Output Current

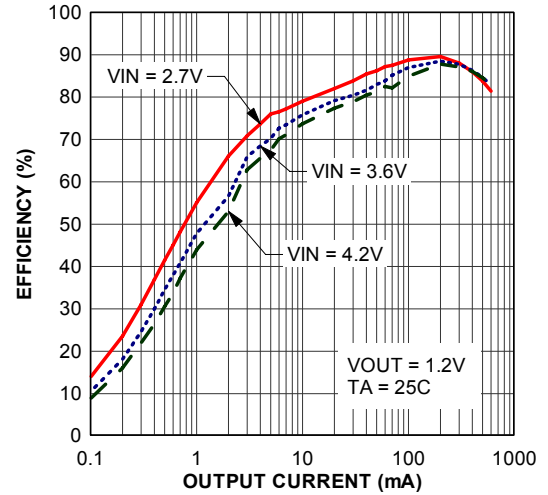

Efficiency vs Output Current

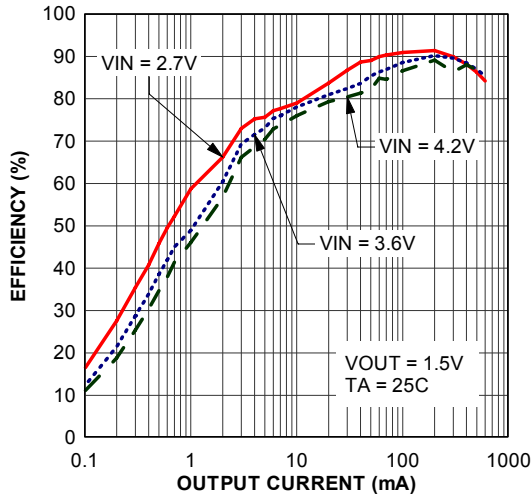

Efficiency vs Output Current

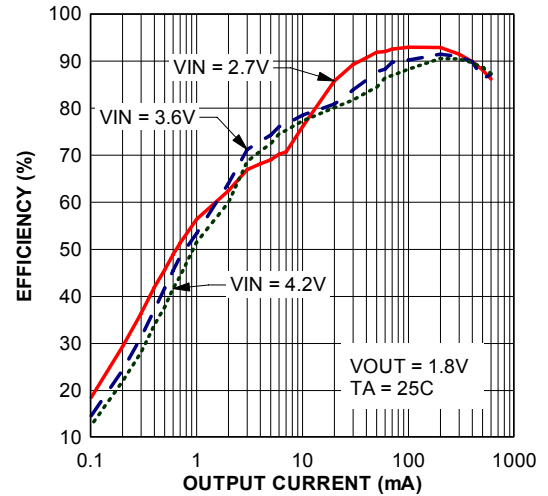

Efficiency vs Output Current

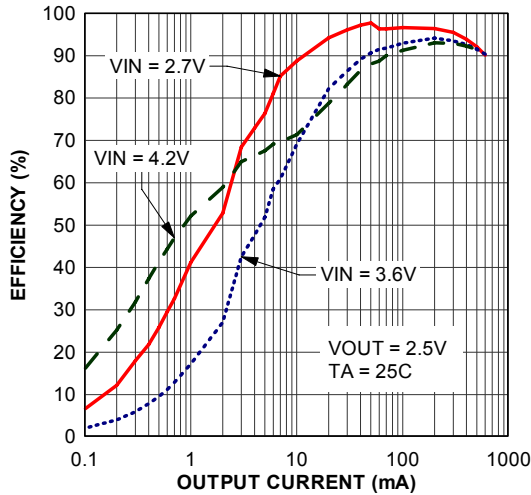

Efficiency vs Load Current

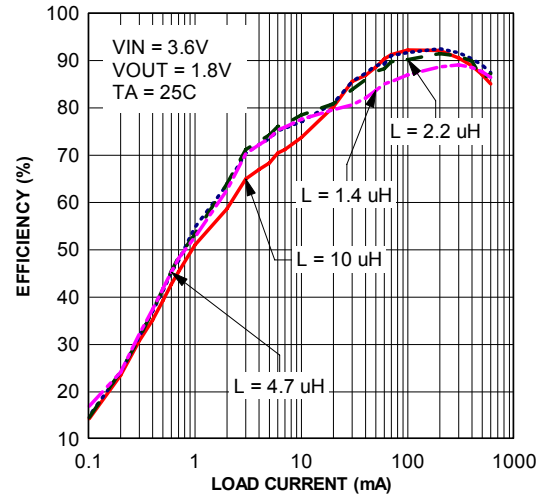

Efficiency vs Load Current

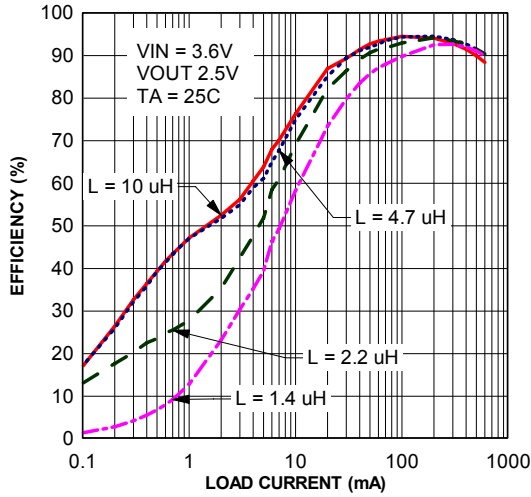

Output Voltage vs Load Current

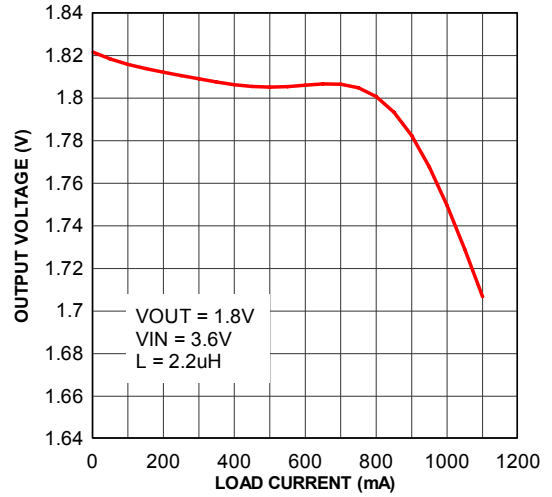

Frequency vs Input Voltage

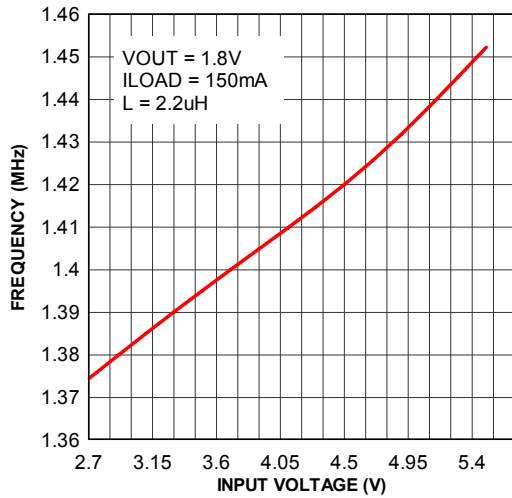

$R_{DS(ON)}$ vs Input Voltage

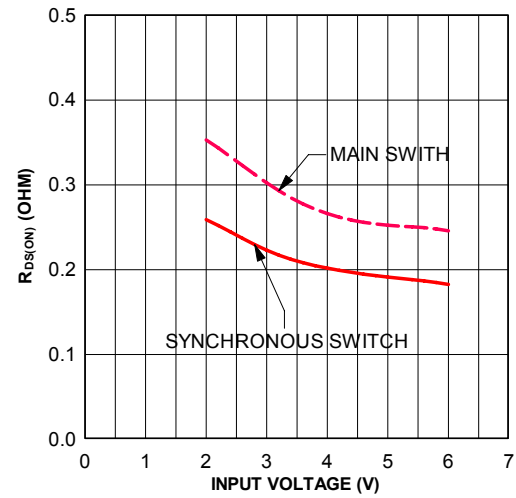

Reference Voltage vs Temperature

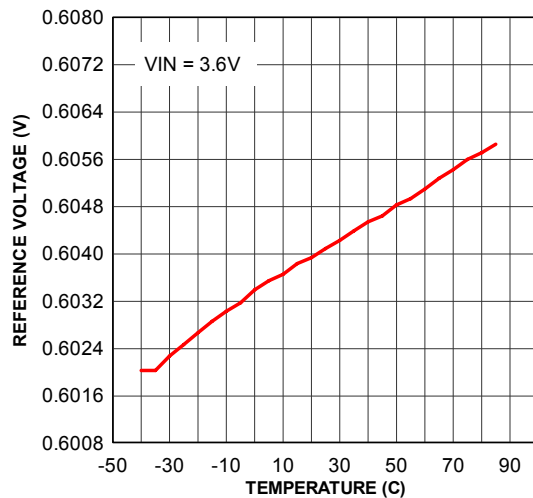

$R_{DS(ON)}$ vs Temperature

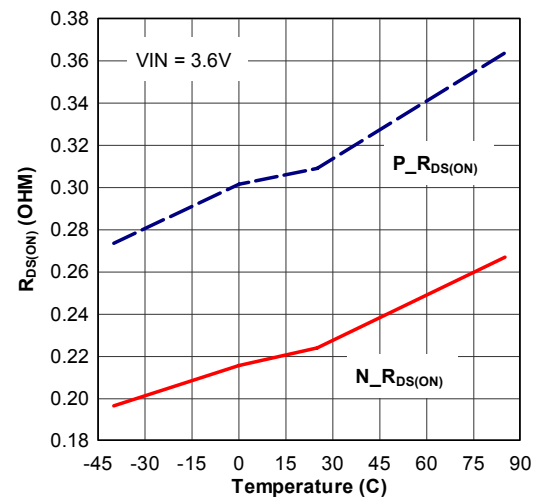

Input Voltage vs Input Current

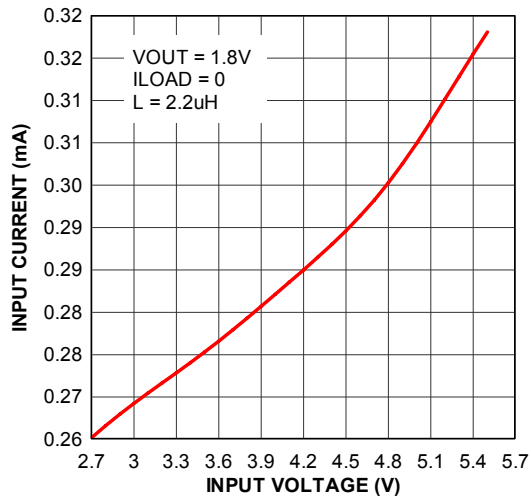

Frequency vs Temperature

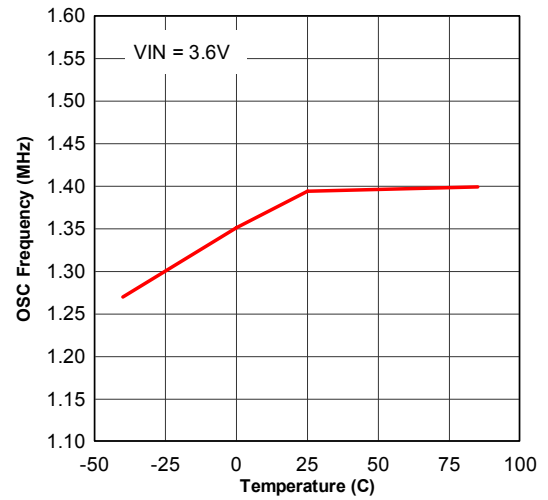

Supply Current vs Temperature

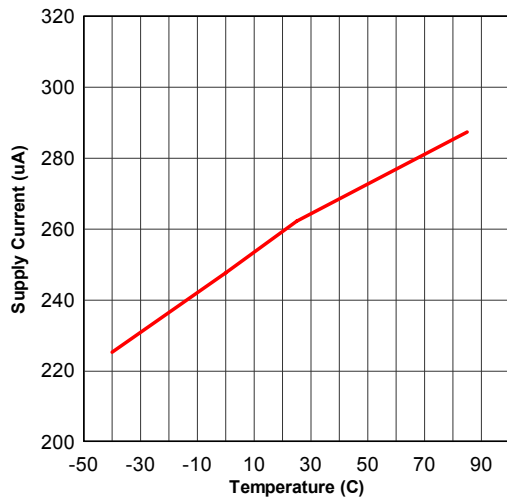

Load Transient Response PWM Mode Only

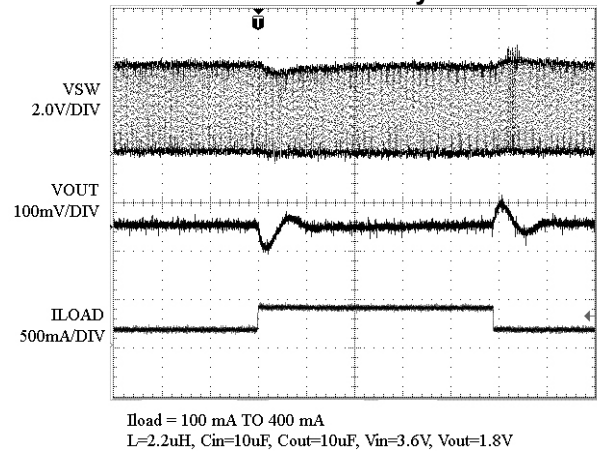

Load Transient Response Pulse Skipping Mode to PWM Mode

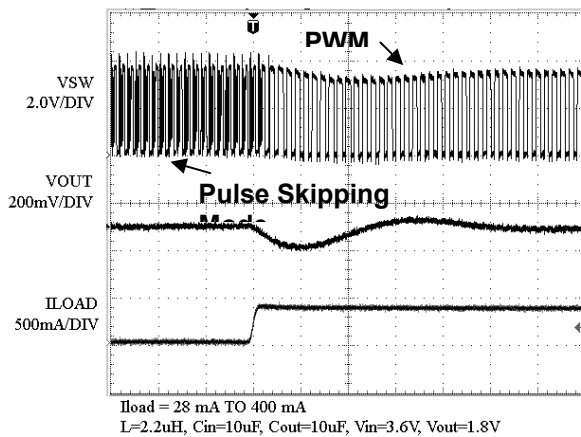

Pin Description

PIN	NAME	FUNCTION
1	RUN	Regulator Enable control input. Drive RUN above 1.5V to turn on the part. Drive RUN below 0.3V to turn it off. In shutdown, all functions are disabled drawing <math><1\mu\text{A}</math> supply current. Do not leave RUN floating.
2	GND	Ground
3	SW	Power Switch Output. It is the Switch node connection to Inductor. This pin connects to the drains of the internal P-CH and N-CH MOSFET switches.
4	IN	Supply Input Pin. Must be closely decoupled to GND, Pin 2, with a 2.2 μF or greater ceramic capacitor.
5	VFB/VOUT	VFB(APS1006ET5): Feedback Input Pin. Connect FB to the center point of the external resistor divider. The feedback threshold voltage is 0.6V. VOUT(APS1006ET5-1.2/APS1006ET5-1.5/APS1006ET5-1.8). Output Voltage Feedback Pin. An internal resistive divider divides the output voltage down for comparison to the internal reference voltage.

Functional Block Diagram

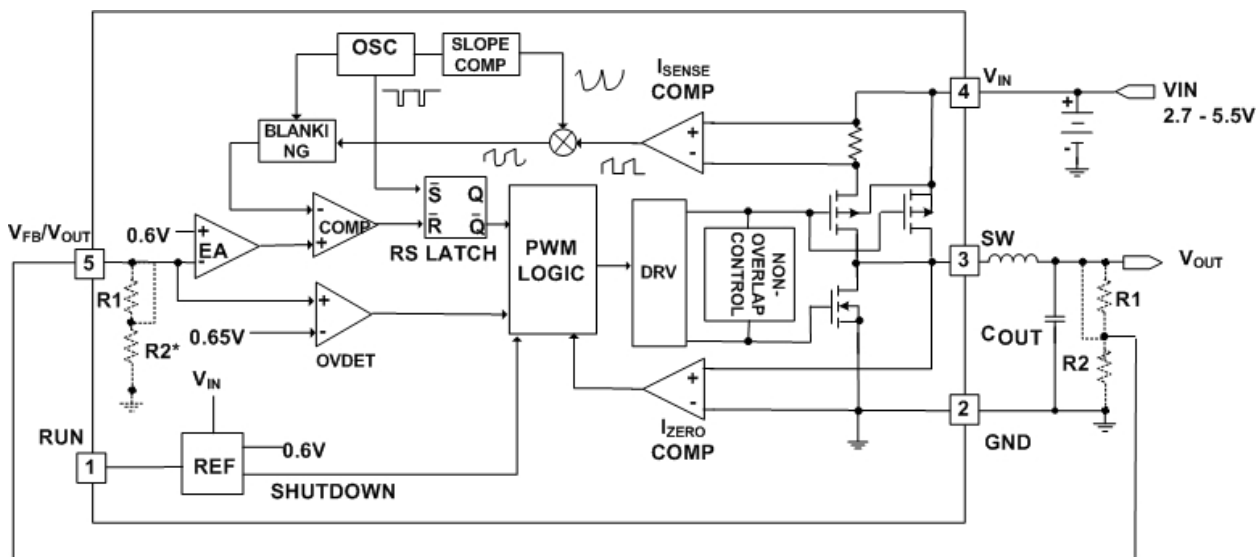

* FOR ADJUSTABLE OUTPUT R1+R2 IS EXTERNAL

Figure 2. APS1006 Block Diagram

Operation

APS1006 is a monolithic switching mode Step-Down DC-DC converter. It utilizes internal MOSFETs to achieve high efficiency and can generate very low output voltage by using internal reference at 0.6V. It operates at a fixed switching frequency, and uses the slope compensated current mode architecture. This Step-Down DC-DC Converter supplies 600mA output current at $V_{IN} = 3V$ with input voltage range from 2.5V to 5.5V.

Current Mode PWM Control

Slope compensated current mode PWM control provides stable switching and cycle-by-cycle current limit for excellent load and line responses and protection of the internal main switch (P-Ch MOSFET) and synchronous rectifier (N-CH MOSFET). During normal operation, the internal P-Ch MOSFET is turned on for a certain time to ramp the inductor current at each rising edge of the internal oscillator, and switched off when the peak inductor current is above the error voltage. The current comparator, I_{COMP} , limits the peak inductor current. When the main switch is off, the synchronous rectifier will be turned on immediately and stay on until either the inductor current starts to reverse, as indicated by the current reversal comparator, I_{ZERO} , or the beginning of the next clock cycle. The OVDET comparator controls output transient overshoots by turning the main switch off and keeping it off until the fault is no longer present.

Pulse Skipping Mode Operation

At very light loads, the APS1006 automatically enters Pulse Skipping Mode. In the Pulse Skipping Mode, the inductor current may reach zero or reverse on each pulse. The PWM control loop will automatically skip pulses to maintain output regulation. The bottom MOSFET is turned off by the current reversal comparator, I_{ZERO} , and the switch voltage will ring. This is discontinuous mode operation, and is normal behavior for the switching regulator.

Dropout Operation

When the input voltage decreases toward the value of the output voltage, the APS1006 allows the main switch to remain on for more than one switching cycle and increases the duty cycle^(Note 5) until it reaches 100%. The output voltage then is the input voltage minus the voltage drop across the main switch and the inductor. At low input supply voltage, the $R_{DS(ON)}$ of the P-Channel MOSFET increases, and the efficiency of the converter decreases. Caution must be exercised to ensure the heat dissipated not to exceed the maximum junction temperature of the IC.

Note 5: The duty cycle D of a step-down converter is defined as:

$$D = T_{ON} \times f_{OSC} \times 100\% \approx \frac{V_{OUT}}{V_{IN}} \times 100\%$$

Where T_{ON} is the main switch on time and f_{OSC} is the oscillator frequency (1.5MHz).

Maximum Load Current

The APS1006 will operate with input supply voltage as low as 2.5V, however, the maximum load current decreases at lower input due to large IR drop on the main switch and synchronous rectifier. The slope compensation signal reduces the peak inductor current as a function of the duty cycle to prevent sub-harmonic oscillations at duty cycles greater than 50%. Conversely the current limit increases as the duty cycle decreases.

Layout Guidance

When laying out the PC board, the following suggestions should be taken to ensure proper operation of the APS1006. These items are also illustrated graphically in Figure 3.

1. The power traces, including the GND trace, the SW trace and the VIN trace should be kept short, direct and wide to allow large current flow. Put enough multiply-layer pads when they need to change the trace layer.
2. Connect the input capacitor C1 to the VIN pin as closely as possible to get good power filter effect.

3. Keep the switching node, SW, away from the sensitive FB node.
4. Do not trace signal line under inductor.

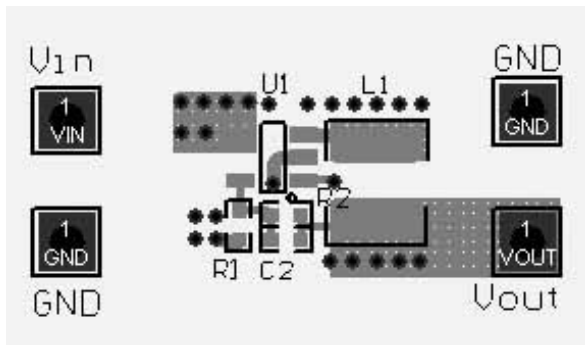
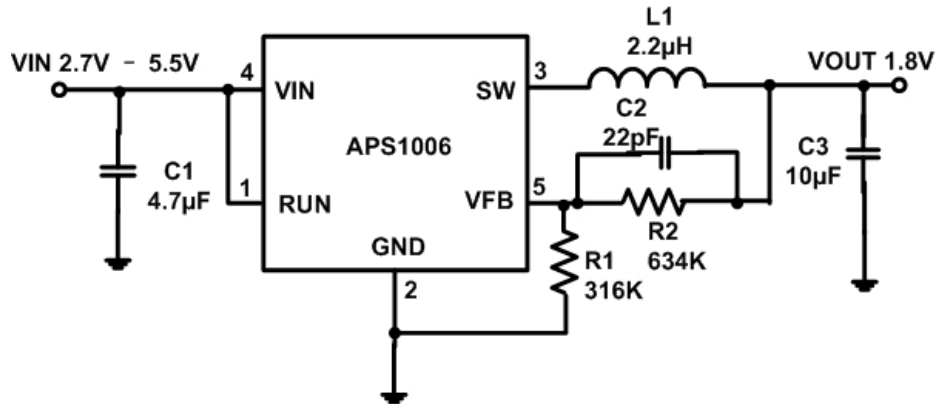

(a) Top Layer

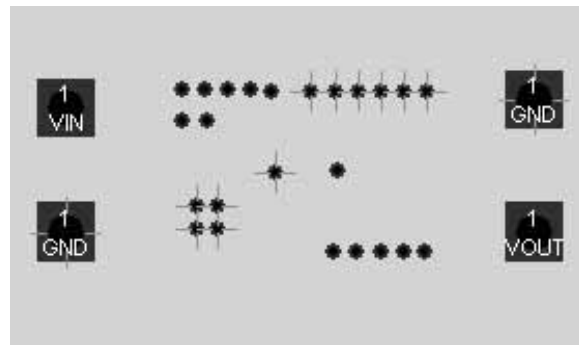

(b) Internal GND Plane

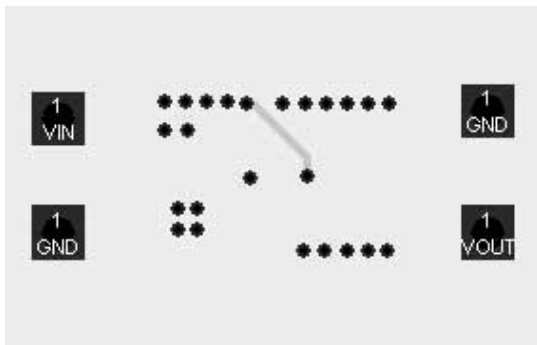

(c) Bottom Layer

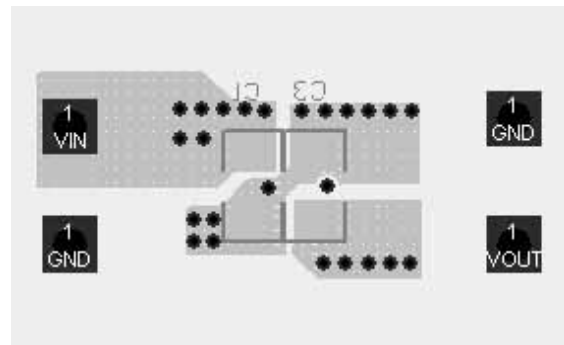

(d) Middle Layer

Figure 3. APS1006 Four Layers Layout Example, with the 2nd and 3rd Internal Plane GND

APPLICATIONS INFORMATION

Figure 4 below shows the basic application circuit with APS1006 fixed output versions.

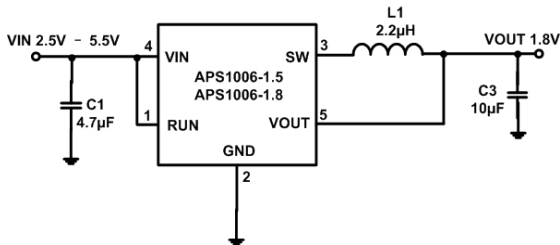

Figure 4. Basic Application Circuit with fixed output versions

Setting the Output Voltage

Figure 1 above shows the basic application circuit with APS1006 adjustable output version. The external resistor sets the output voltage according to the following equation:

$$V_{OUT} = 0.6V \times \left(1 + \frac{R2}{R1}\right)$$

Table 1 Resistor select for output voltage setting

V _{OUT}	R1(R3)	R2(R4)
1.2V	316k	316k
1.5V	316k	470k
1.8V	316k	634k
2.5V	316k	1000k

Inductor Selection

For most designs, the APS1006 operates with inductors of 1µH to 4.7µH. Low inductance values are physically smaller but require faster switching, which results in some efficiency loss. The inductor value can be derived from the following equation:

$$L = \frac{V_{OUT} \times (V_{IN} - V_{OUT})}{V_{IN} \times \Delta I_L \times f_{OSC}}$$

Where ΔI_L is inductor Ripple Current. Large value inductors lower ripple current and small value inductors result in high ripple currents. Choose inductor ripple current approximately 35% of the maximum load current 600mA, or $\Delta I_L = 210mA$.

For output voltages above 2.0V, when light-load efficiency is important, the minimum recommended inductor is 2.2µH. For optimum voltage-positioning load transients, choose an inductor with DC series resistance in the 50mΩ to 150mΩ range. For higher efficiency at heavy loads (above 200mA), or minimal load regulation (but some transient overshoot), the resistance should be kept below 100mΩ. The DC current rating of the inductor should be at least equal to the maximum load current plus half the ripple current to prevent core saturation (600mA+105mA). Table 2 lists some typical surface mount inductors that meet target applications for the APS1006.

Table 2. Typical Surface Mount Inductors

Part #	L (µH)	Max DCR (mΩ)	Rated D.C. Current (A)	Size WxLxH (mm)
Sumida CR43	1.4	56.2	2.52	4.5x4.0x3.5
	2.2	71.2	1.75	
	3.3	86.2	1.44	
	4.7	108.7	1.15	
Sumida CDRH4D18	1.5	75	1.32	4.7x4.7x2.0
	2.2	110	1.04	
	4.7	162	0.84	
Toko D312C	1.5	120	1.29	3.6x3.6x1.2
	2.2	140	1.14	
	3.3	180	0.98	
	4.7	240	0.79	

Input Capacitor Selection

The input capacitor reduces the surge current drawn from the input and switching noise from the device. The input capacitor impedance at the switching frequency shall be less than input source impedance to prevent high frequency switching current passing to the input. A low ESR input capacitor sized for maximum RMS current must be used. Ceramic capacitors with X5R or X7R dielectrics are highly recommended because of their low ESR and small temperature coefficients. A 4.7µF ceramic capacitor for most applications is sufficient.

Output Capacitor Selection

The output capacitor is required to keep the output voltage ripple small and to ensure regulation loop stability. The output capacitor must have low impedance at the switching frequency. Ceramic capacitors with X5R or X7R dielectrics are recommended due to their low

ESR and high ripple current. The output ripple V_{OUT} is determined by:

$$\Delta V_{OUT} \leq \frac{V_{OUT} \times (V_{IN} - V_{OUT})}{V_{IN} \times f_{OSC} \times L} \times \left(ESR + \frac{1}{8 \times f_{osc} \times C3} \right)$$

Package Description

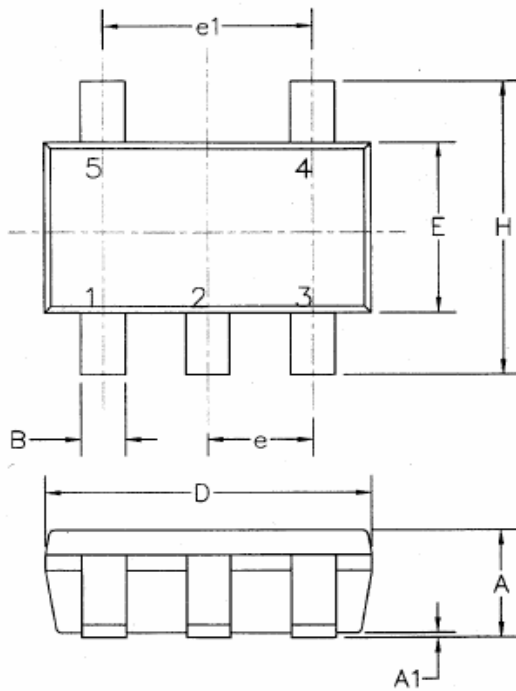

5LD SOT-23 PACKAGE OUTLINE DIMENSIONS
ALL DIMENSIONS IN MM.

Dimension	Min.	Max.
A	0.9	1.10
A1	0.01	0.13
B	0.3	0.5
C	0.09	0.2
D	2.8	3.0
H	2.5	3.1
E	1.5	1.7
e	0.95 REF.	
e1	1.90 REF.	
L1	0.2	0.55
L	0.35	0.8
Q	0°	10°

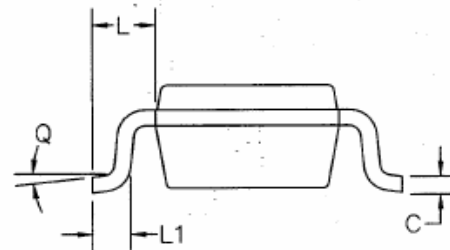

Note: Package outline exclusive of mold flash and metal burr.

RELATED PARTS

Part Number	Description	Comments
APS1006	1.5 MHz, 600mA Synchronous Step-Down Converter	PWM and Pulse Skipping Mode operation.
APS1016	1.5 MHz, 600mA Synchronous Step-Down Converter with Low Quiescent Current	PWM and Power Saving Mode operation.
APS1026	Dual Channel 1.5 MHz, 600mA Synchronous Step-Down DC-DC Converter with Low Quiescent Current	Dual Channel version of the APS1016 with selectable Pulse Skipping Mode and Power Saving Mode operation.
APS1126	Dual Channel 1.5 MHz, 600mA Synchronous Step-Down DC-DC Converter	Dual Channel version of the APS1006 with Pulse Skipping Mode operation.

IMPORTANT NOTICE

Analog Power Semiconductor (Shanghai) Co., Ltd. reserves the right to make changes without further notice to any products or specifications herein. Analog Power Semiconductor (Shanghai) Co., Ltd. does not assume any responsibility for use of any its products for any particular purpose, nor does Analog Power Semiconductor (Shanghai) Co., Ltd assume any liability arising out of the application or use of any its products or circuits. Analog Power Semiconductor (Shanghai) Co., Ltd does not convey any license under its patent rights or other rights nor the rights of others.

Analog Power Semiconductor
IPCore Technologies (Shanghai) Co., Ltd.
11 Floor, Block B, Hi-Tech Building, 900 Yishan Road,
Shanghai, 200233, P.R. China
Tel: (8621) 5423-5088
Fax: (8621) 5423-5256
<http://www.apsemi.com>; <http://www.ipcoreinc.com>