

High Density FPC Connector (0.3mm/0.4mm/0.5mm Pitch)

FH16 Series



FH16 Series Variation

0.3mm pitch 60 contact	
0.3mm pitch 80 contact	
0.3mm pitch 90 contact	
0.4mm pitch 80 contact	
0.5mm pitch 50 contact	
0.5mm pitch 64 contact	
[Conventional product (FH12 series)]	
0.5mm pitch 30 contact	

Features

1. High Density FPC Connector

The FH16 series is a fine pitch, zero insertion force (ZIF), right angle, bottom contact, connector compatible with flexible printed circuits (FPC) with a pitch of 0.3mm, 0.4mm, and 0.5mm and a recommended thickness of 0.293mm for single-sided or 0.297mm for double-sided. The FH16 provides a higher pin count given the same amount of board space than other manufacturers of similar product. With a large selection in pin density, the FH16 series greatly improves design flexibility.

- FH16 : 0.3mm pitch 60, 80, and 90 contacts
- FH16M : 0.4mm pitch 80 and 96 contacts
- FH16H : 0.5mm pitch 50 contacts
- FH16P : 0.5mm pitch 64 contacts

2. Easy mounting on PCB

FH16 supports 0.3mm pitch cable but only requires a 0.6mm pitch pad layout on the PCB. The FH16's staggered pin design allows the mounting lead area to be twice as wide as the FPC contact area making it easier to place the connector on the board given the fine pitch of the contacts.

3. User Friendly Flip-Lock Design

The flip-lock (one-touch rotating type) ZIF structure secures the FPC connection with a single and light force. This design helps simplify assembly and repair work. When locking the FPC, the audible click assures the assembly worker of a steady FPC connection resulting in improved customer service.

4. Prevents FPC from escape and oblique mating

The FH16 series with its recommended FPC dimensions prevents the FPC from escape and oblique mating thereby securing a steady connection.

5. Compatible with Automatic Assembly Tooling

Embossed tape packaging allows for automatic placement onto the PCB.

Applications

Notebook PC, printers, PDAs, digital cameras and other compact devices for interconnecting the main circuit board with the LCD, PDP (Plasma Display), HDD or other device.

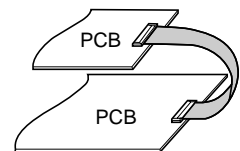
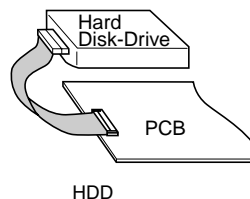
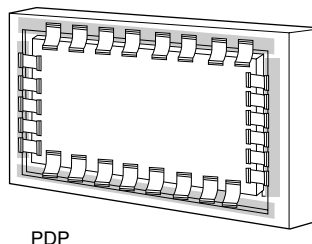
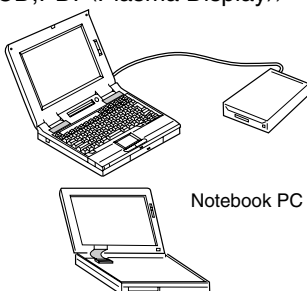

Excellent Serviceability with Flip-Lock Design

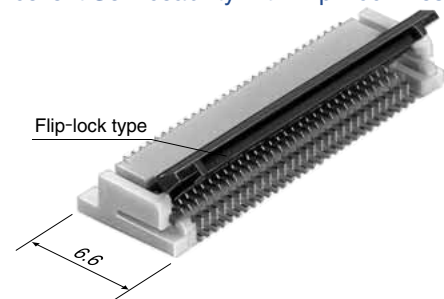

Mechanism to prevent FPC from escape and oblique mating

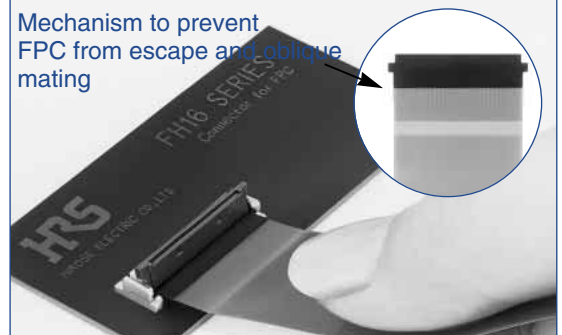

Product Specifications

Ratings	Pitch	0.3mm	0.4mm	0.5mm	Operating Temperature Range: -40°C to +70°C(Note 2)	Storage Temperature Range: -10°C to +50°C(Note 3)
	Current rating(Note 1)	0.15A	0.3A	0.4A		
	Voltage rating	30V AC	50V AC	60V AC		

Applicable cable t=0.30 ±0.05, gold plated

Item	Specification	Conditions
1. Insulation resistance	500M ohms min.	100V DC
2. Withstanding voltage	No flashover or insulation breakdown.	0.3mm pitch: 90V AC 0.4mm pitch: 150V AC /one minute 0.5mm pitch: 200V AC
3. Contact resistance	150m ohms max. *Including FPC conductor resistance.	1mA
4. Durability (Insertion/withdrawal)	150m ohms max. No damage, cracks, or parts dislocation.	20 cycles
5. Vibration	No electrical discontinuity of 1μs or more Contact resistance: 150m ohms max. No damage, cracks, or parts dislocation.	Frequency: 10 to 55 Hz, single amplitude of 0.75 mm, 2 hours in each of the 3 directions.
6. Shock	No electrical discontinuity of 1μs or more Contact resistance: 150m ohms max. No damage, cracks, or parts dislocation.	Acceleration of 490 m/s ² , 11 ms duration, sine half-wave waveform, 3 cycles in each of the 3 axis.
7. Humidity (Steady state)	Contact resistance: 150m ohms max. Insulation resistance: 50M ohms min. No damage, cracks, or parts dislocation.	96 hours at 40°C and humidity of 90% to 95%
8. Temperature cycle	Contact resistance: 150m ohms max. Insulation resistance: 50M ohms min. No damage, cracks, or parts dislocation.	Temperature: -40°C → +15 to 35°C → +85°C → +15 to 35°C Time : 30 minutes → 5 minutes max. → 30 minutes → 5 minutes max. 5 cycles
9. Resistance to Soldering heat	No deformation of components affecting performance.	Reflow: At the recommended temperature profile Manual soldering: 350°C for 3 seconds

Note 1: When passing the current through all of the contacts, use 70% of the current rating.

Note 2: Includes temperature rise caused by current flow.

Note 3: The term "storage" refers to products stored for long period of time prior to mounting and use. Operating Temperature Range and Humidity range covers nonconducting condition of installed connectors in storage, shipment or during transportation.

Materials

Part	Material	Finish	Remarks
Insulator	Polyamide	Color : Beige	UL94V-0
	LCP		
Actuator	PPS	Color : Dark brown	
Contact	Phosphor bronze	Gold plated	———



Ordering Information

FH16 - 64S - 0.5 SHW (05)

① ② ③ ④ ⑤

① Series name	: FH16
② Number of contacts	: 50, 60, 64, 80, 90, and 96 contacts
③ Contact pitch	: 0.3mm, 0.4mm, 0.5mm
④ Terminal Shape	: SHW(SMT horizontal staggered row mount type)
⑤ Plating Specification	: (05) : gold flash plated(RoHS compliant)

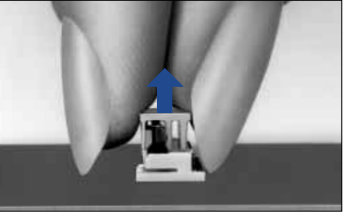
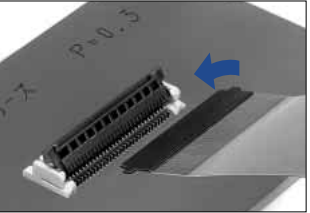
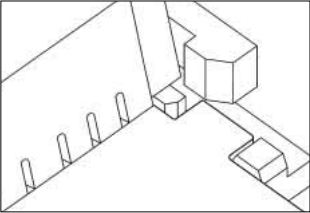
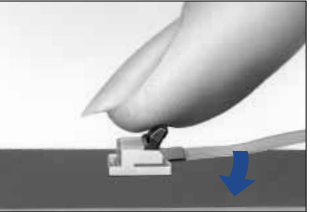
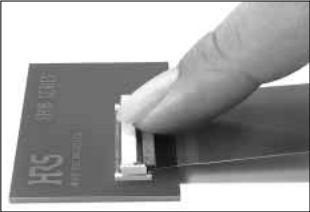
◆ Connector Operating Instructions, precautions and recommendations

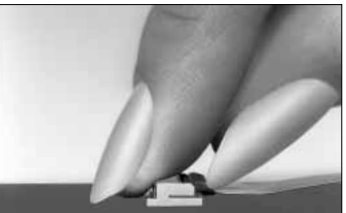
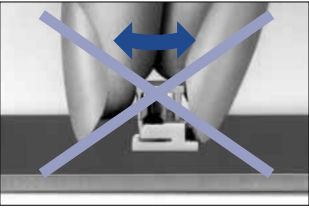
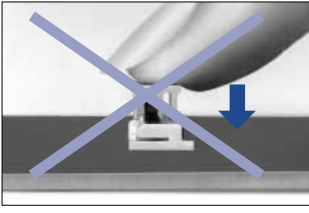
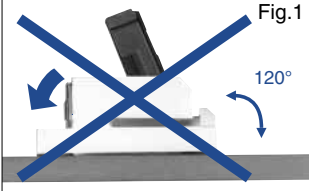
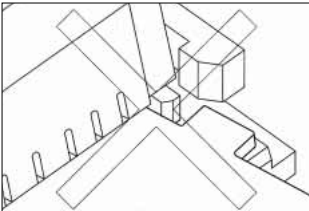
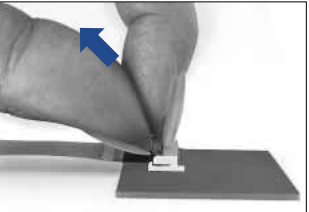
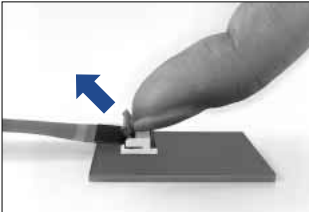
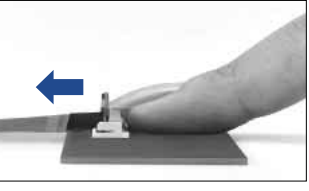
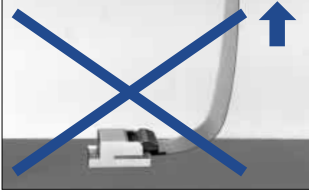
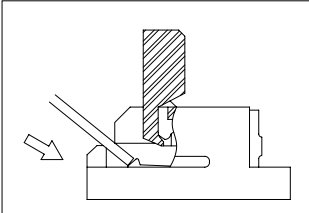
Operation	Precautions
<p>1.FPC Termination procedure. Connector installed on the board.</p> <p>1) Remove and dispose the pick-and-place insert.</p>  <p>2) Fully insert the FPC parallel to mounting surface, with the exposed conductive traces facing down.</p>   <p>3) Rotate down the actuator until firmly closed. It is critical that the inserted FPC is not moved and remains fully inserted. Should the FPC be moved, open the actuator and repeat the process, starting with Step 1</p>   <p>Rotate down, pushing at each end, to a fully closed position.</p>  <p>2.FPC Removal</p> <p>1) Lift up the actuator. 2) Carefully remove the FPC.</p> 	<p>1) When removing the pick-and place cover,avoid actions such as twisting the cover,or pressing down on it, etc. Such actions will cause the actuator to come off.</p>   <p>2) The connector will assure reliable performance when the actuator is open to 120° maximum (see fig.1) Do not exceed this angle, as this may cause permanent damage to the connector.</p>  <p>3) Properly insert the FPC at the positioning part of the connector. Locking the FPC while it is partially inserted, may cause lock damage, disconnection of the FPC, or continuity fault.</p>  <p>4) Do NOT push/pull actuator. Any damage to actuator will require replacement of the entire connector.</p>    <p>5) Properly insert the FPC at the positioning part of the connector. Locking the FPC while it is partially inserted, may cause lock damage, disconnection of the FPC, or continuity fault.</p>  <p>6) When inserting the FPC, do not forcefully rub against the bottom surface of the connector insertion entrance. Doing so will result in the contacts and FPC making strong contact and may cause deformation of the contacts, peeling of the FPC conductor, and other problems.</p> 

Do not apply force in the upward direction (as illustrated). Do not bend the FPC too close to the actuator.

Connector Dimensions

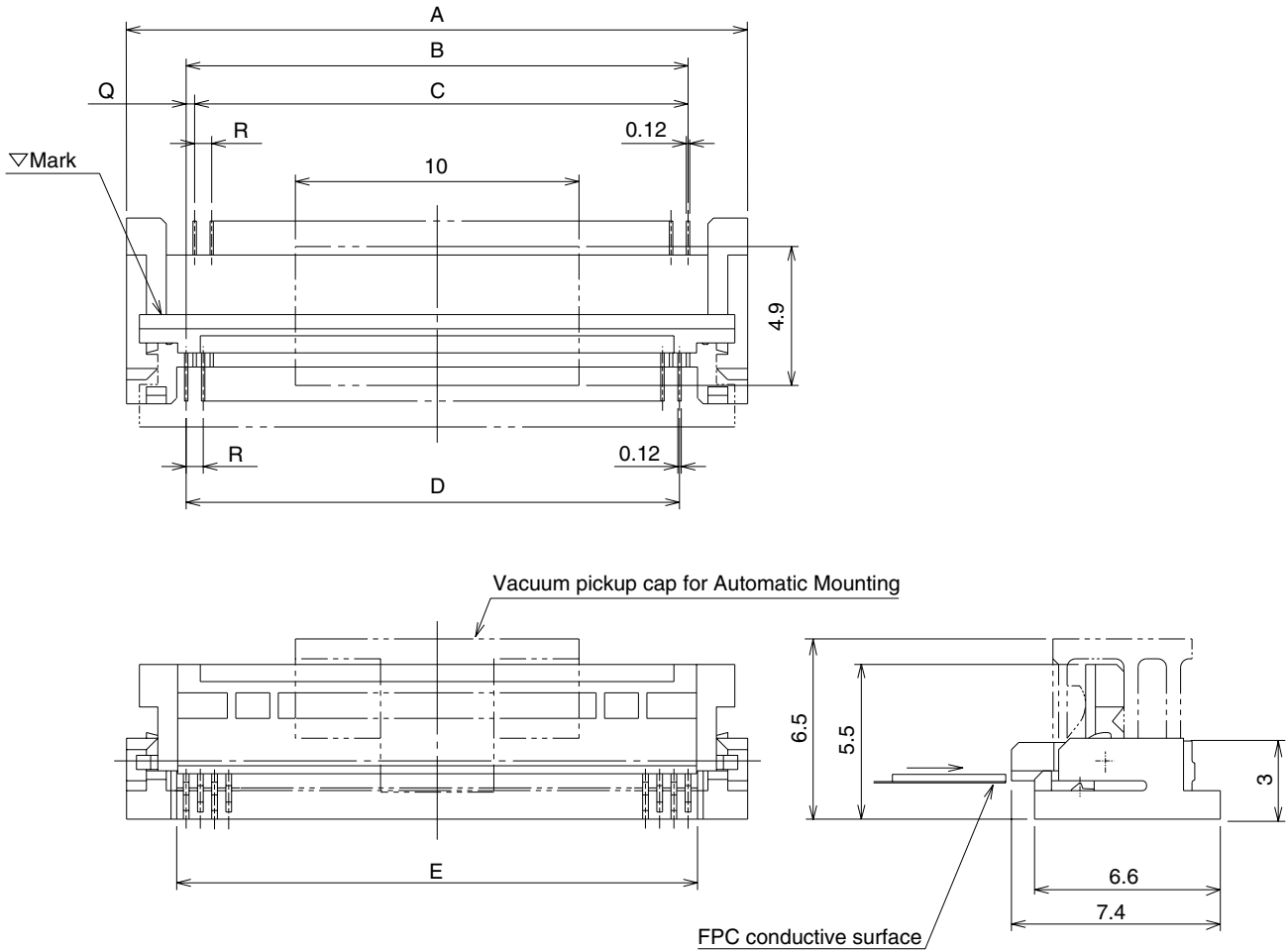

Unit: mm

Part Number	CL No.	Number of contacts	FPC Contact Pitch	A	B	C	D	E	Q	R	RoHS
FH16-60S-0.3SHW(05)	586-0620-2-05	60	0.3	21.9	17.7	17.4	17.4	18.35	0.3	0.6	YES
FH16-80S-0.3SHW(05)	586-0613-7-05	80	0.3	27.9	23.7	23.4	23.4	24.35	0.3	0.6	
FH16-90S-0.3SHW(05)	586-0697-7-05	90	0.3	30.9	26.7	26.4	26.4	27.35	0.3	0.6	
FH16M-80S-0.4SHW(05)	586-0675-4-05	80	0.4	36.1	31.6	31.2	31.2	32.25	0.4	0.8	
FH16M-96S-0.4SHW(05)	586-0715-7-05	96	0.4	42.5	38	37.6	37.6	38.65	0.4	0.8	
FH16H-50S-0.5SHW(05)	586-0676-7-05	50	0.5	29.4	24.5	24	24	25.55	0.5	1	
FH16P-64S-0.5SHW(05)	586-0649-4-05	64	0.5	36	31.5	31	31	32.15	0.5	1	

Note 1: Embossed tape reel packaging (1,000 pieces/reel)

Order by number of reels.

◆ Recommended PCB layout and metal mask dimensions

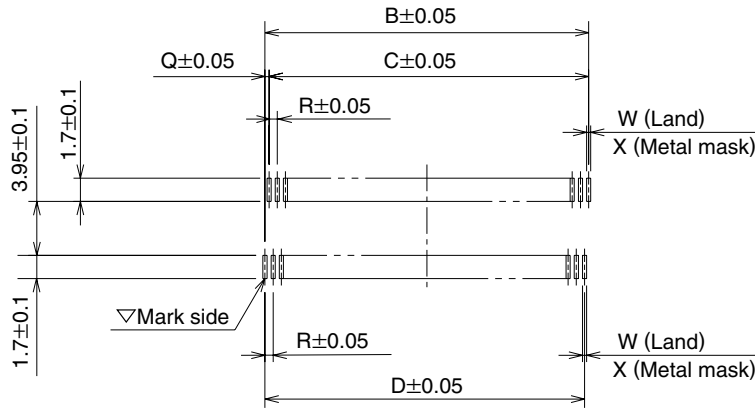

* Recommended metal mask thickness: $t=0.15$

◆ FPC recommended dimensions

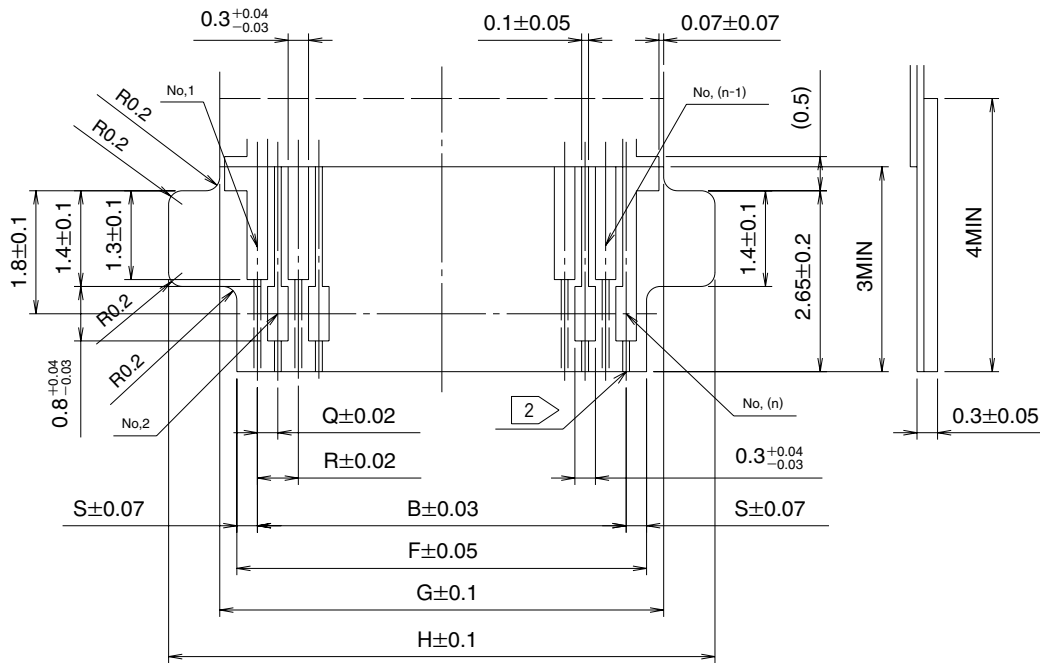

1 Stiffener material shall be polyimide + thermal hardened additives.

2 Conductor width shall be 0.1 ± 0.05 if FPC has plating bars.

FPC, Land, Metal Mask Dimension

Unit: mm

Part Number	CL No.	Number of contacts	FPC Contact Pitch	B	C	D	F	G	H	Q	R	S	W	X
FH16-60S-0.3SHW(05)	586-0620-2-05	60	0.3	17.7	17.4	17.4	18.3	18.8	20.3	0.3	0.6	0.3	0.3 ± 0.03	0.25 ± 0.03
FH16-80S-0.3SHW(05)	586-0613-7-05	80	0.3	23.7	23.4	23.4	24.3	24.8	26.3	0.3	0.6	0.3	0.3 ± 0.03	0.25 ± 0.03
FH16-90S-0.3SHW(05)	586-0697-7-05	90	0.3	26.7	26.4	26.4	27.3	27.8	29.3	0.3	0.6	0.3	0.3 ± 0.03	0.25 ± 0.03
FH16M-80S-0.4SHW(05)	586-0675-4-05	80	0.4	31.6	31.2	31.2	32.2	32.7	34.2	0.4	0.8	0.3	0.3 ± 0.03	0.25 ± 0.03
FH16M-96S-0.4SHW(05)	586-0715-7-05	96	0.4	38	37.6	37.6	38.6	39.1	40.6	0.4	0.8	0.3	0.3 ± 0.03	0.25 ± 0.03
FH16H-50S-0.5SHW(05)	586-0676-7-05	50	0.5	24.5	24	24	25.5	25.5	27.5	0.5	1	0.5	0.6 ± 0.1	0.5 ± 0.05
FH16P-64S-0.5SHW(05)	586-0649-4-05	64	0.5	31.5	31	31	32.1	32.6	34.1	0.5	1	0.3	0.6 ± 0.1	0.5 ± 0.05

◆ Packaging Specification

● Embossed Carrier Tape Dimensions

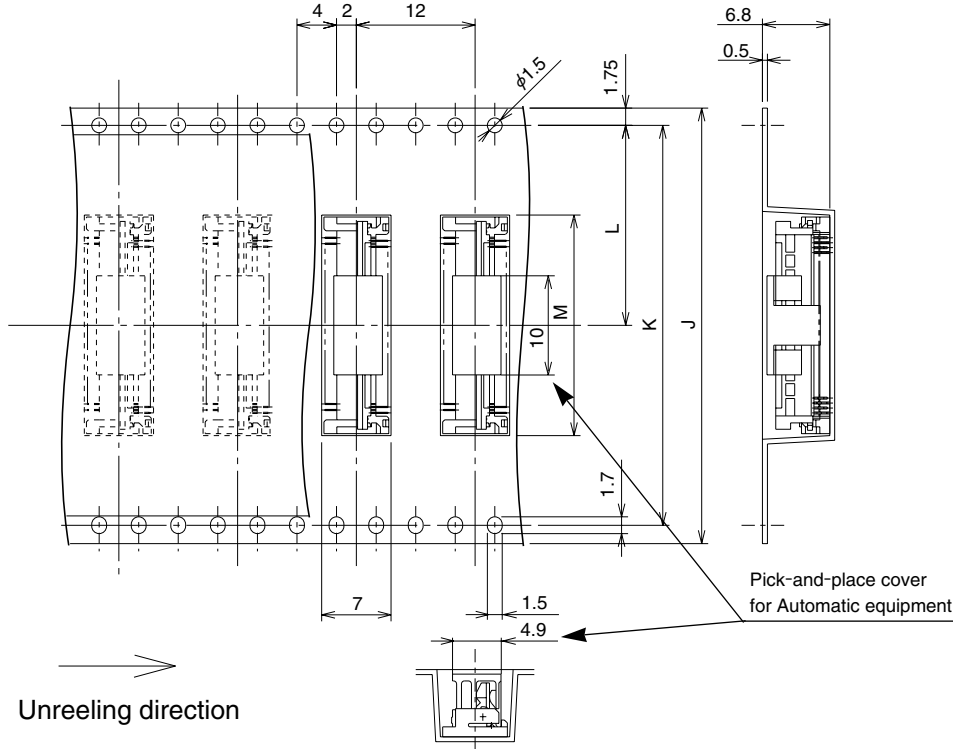

Unit: mm

Inserted Connector	Number of Contacts	J	K	L	M	T	U
FH16-60S-0.3SHW(05)	60	44	40.4	20.2	22.3	45.4	49.4
FH16-80S-0.3SHW(05)	80	44	40.4	20.2	28.3	45.4	49.4
FH16-90S-0.3SHW(05)	90	44	40.4	20.2	31.3	45.4	49.4
FH16M-80S-0.4SHW(05)	80	56	52.4	26.2	36.6	57.4	61.4
FH16M-96S-0.4SHW(05)	96	56	52.4	26.2	43	57.4	61.4
FH16H-50S-0.5SHW(05)	50	44	40.4	20.2	29.9	45.4	49.4
FH16P-64S-0.5SHW(05)	64	56	52.4	26.2	36.6	57.4	61.4

Note: 1,000 pieces per reel.

● Reel Dimensions

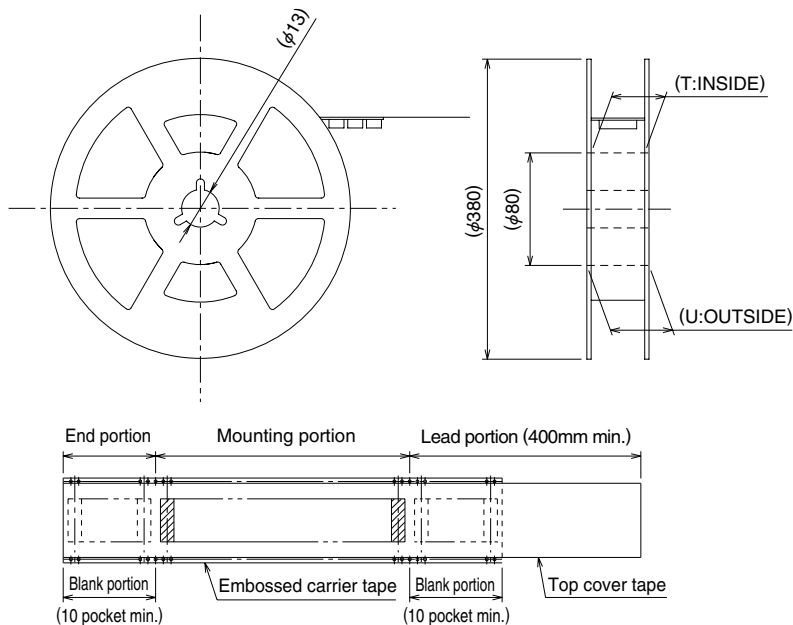

◆ Recommended Temperature Profile

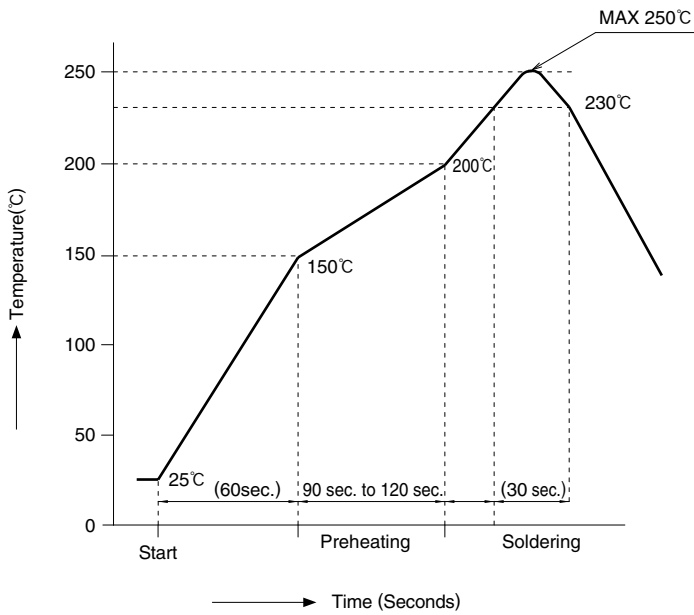

HRS test conditions

Solder method	:Reflow, IR/hot air (Nihon Den-netsu Co., Ltd.'s Part Number: SENSBY NR- II)
Environment	:Room air
Solder composition	:Paste, 96.5%Sn/3.0%Ag/0.5%Cu (Senju Metal Industry, Co., Ltd.'s Part Number: M705-221CM5-42-10.5)
Test board	:Glass epoxy 45mm×80mm×1.6mm thick
Land dimensions	:Contact Pitch 0.3mm, 0.4mm 0.3mm×1.7mm 0.5mm 0.6mm×1.7mm
Metal mask	:Contact Pitch 0.3mm, 0.4mm 0.25mm×1.7mm×0.15mm thick 0.5mm 0.5mm×1.7mm×0.15mm thick

The temperature profiles shown are based on the above conditions. In individual applications the actual temperature may vary, depending on solder paste type, volume / thickness and board size / thickness. Consult your solder paste and equipment manufacturer for specific recommendations.

◆FH16 Series FPC Construction (Recommended Specifications)

1. Using Single-Sided FPC

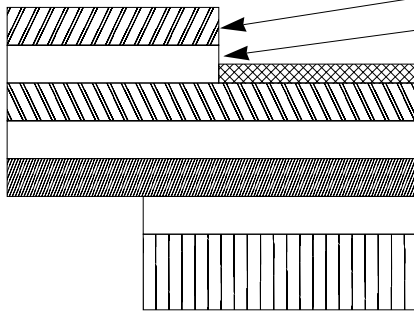

Material Name	Material	Thickness (μm)
Covering layer film	Polyimide 1 mil	25
Cover adhesive		25
Surface treatment	1 to 5 μm nickel under plated/ 0.2 μm gold plated	3
Copper foil	Cu 1oz	35
Base adhesive		25
Base film	Polyimide 1 mil	25
Reinforcement material adhesive	Heat-hardened adhesive	30
Stiffener	Polyimide 7 mil	175
Total		293

2. Using Double-Sided FPC

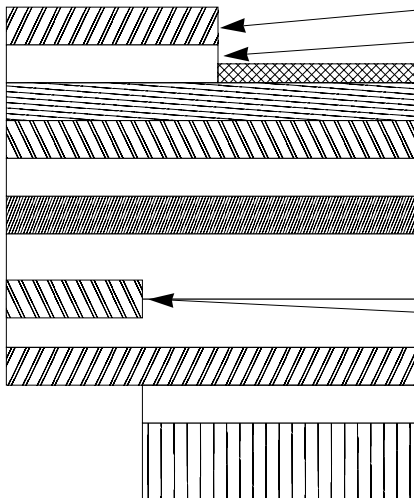

Material Name	Material	Thickness (μm)
Covering layer film	Polyimide 1 mil	25
Cover adhesive		25
Surface treatment	1 to 5 μm nickel plated/ 0.2 μm gold plated	3
Through hole copper	Cu	15
Copper foil	Cu 1/2 oz	18
Base adhesive		18
Base film	Polyimide 1 mil	25
Base adhesive		18
Copper foil	Cu 1/2 oz	18
Cover adhesive		25
Cover layer film	Polyimide 1 mil	25
Reinforcement material adhesive	Heat-hardened adhesive	50
Stiffener	Polyimide 1 mil	100
Total		297

Note : To prevent release of the lock due to FPC bending,
 please do not use copper foil on the rear side.

3. Precautions

1. This specification is a recommendation for the construction of the FH16 Series FPC ($t=0.3 \pm 0.05$).
2. The FH16 Series are connectors for thin FPC which is beginning to be used in cameras and other miniature equipment. Stiffener is not required for double-sided FPC which will be reflected in FPC cost reduction. Please note that in the case of single-sided FPC, stiffener is required, but the thickness dimension can be created easily. For details about the construction, please contact the FPC manufacturer.