

**FEATURES**

- \* HIGH PHOTO SENSITIVITY
- \* SUITABLE FOR INFRARED RADIATION
- \* LOW JUNCTION CAPACITANCE
- \* HIGH CUT-OFF FREQUENCY
- \* FAST SWITCHING TIME
- \* THE LTR-516AD IS A SPECIAL DARK GREEN PLASTIC PACKAGE THAT CUT THE VISIBLE LIGHT AND SUITABLE FOR THE DETECTORS OF INFRARED APPLICATIONS

**PACKAGE DIMENSIONS****NOTES:**

1. All dimensions are in millimeters (inches).
2. Tolerance is  $\pm 0.25\text{mm}(.010\text{'})$  unless otherwise noted.
3. Protruded resin under flange is 1.5mm(.059") max.
4. Lead spacing is measured where the leads emerge from the package.
5. Specifications are subject to change without notice.

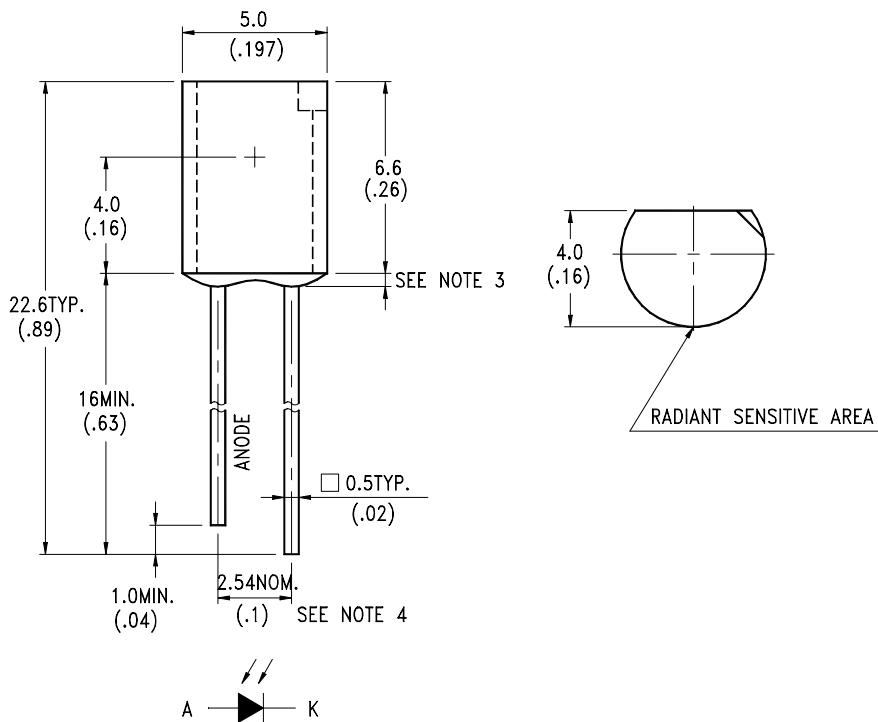

# LITE-ON ELECTRONICS, INC.

Property of Lite-On Only

## ABSOLUTE MAXIMUM RATINGS AT TA=25°C

PARAMETER	MAXIMUM RATING	UNIT
Power Dissipation	150	mW
Collector-Emitter Voltage	30	V
Operating Temperature Range	-40°C to +85°C	
Storage Temperature Range	-55°C to +100°C	
Lead Soldering Temperature [1.6mm(.063") From Body]	260°C for 5 Seconds	

## ELECTRICAL OPTICAL CHARACTERISTICS AT TA=25°C

PARAMETER	SYMBOL	MIN.	TYP.	MAX.	UNIT	TEST CONDITION
Reverse Break Down Voltage	V <sub>(BR)R</sub>	30			V	I <sub>R</sub> = 100 μA E <sub>e</sub> = 0mW/cm <sup>2</sup>
Reverse Dark Current Voltage	I <sub>D(R)</sub>			30	nA	V <sub>R</sub> = 10V E <sub>e</sub> = 0mW/cm <sup>2</sup>
Open Circuit Voltage	V <sub>OC</sub>		350		mV	λ = 940nm E <sub>e</sub> = 0.5mW/cm <sup>2</sup>
Rise Time	T <sub>r</sub>		50		nsec	V <sub>R</sub> = 10V λ = 940nm R <sub>L</sub> = 1KΩ
Fall Time	T <sub>f</sub>		50		nsec	
Short Circuit Current	I <sub>S</sub>	1.7	2		μA	V <sub>R</sub> = 5V λ = 940nm E <sub>e</sub> = 0.1mW/cm <sup>2</sup>
Total Capacitance	C <sub>T</sub>		25		P	V <sub>R</sub> = 3V f = 1MHZ E <sub>e</sub> = 0mW/cm <sup>2</sup>
Wavelength of the Max Sensitivity	λ <sub>S MAX</sub>		900		nm	

## TYPICAL ELECTRICAL / OPTICAL CHARACTERISTICS CURVES

(25°C Ambient Temperature Unless Otherwise Noted)

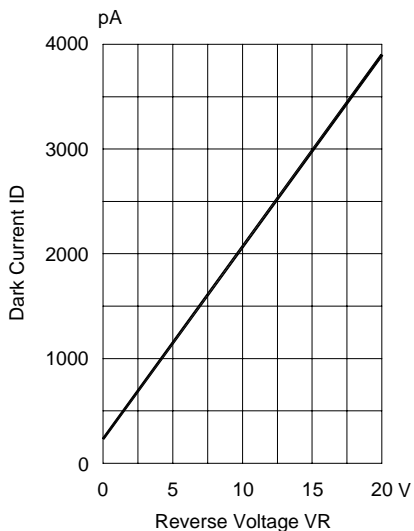

Fig.1 DARK CURRENT VS. REVERSE VOLTAGE  
TA=25°C, Ee=0mW/cm<sup>2</sup>

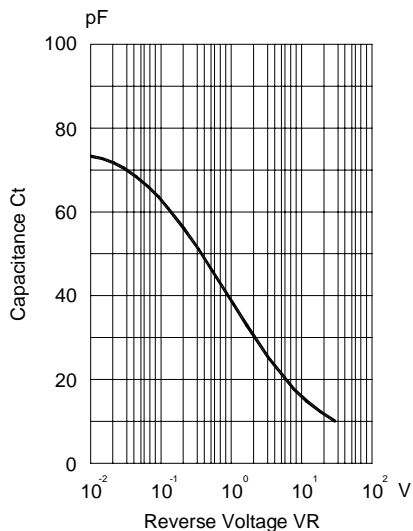

Fig.2 CAPACITANCE VS. REVERSE VOLTAGE  
F=1MHZ; Ee=0mW/cm<sup>2</sup>

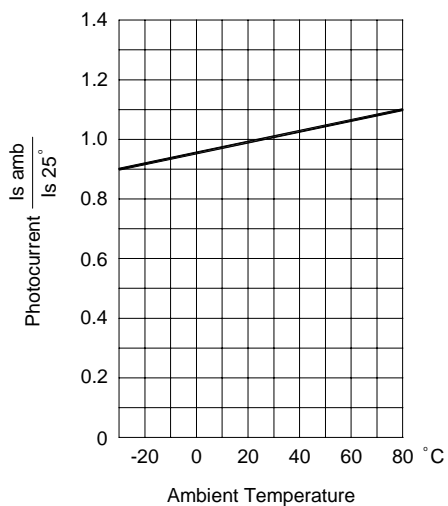

Fig.3 PHOTOCURRENT VS. AMBIENT TEMPERATURE

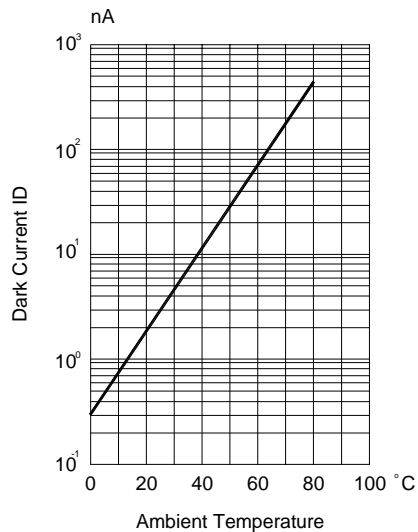

Fig.4 DARK CURRENT VS. AMBIENT TEMPERATURE  
VR=10, Ee=0mW/cm<sup>2</sup>

**TYPICAL ELECTRICAL / OPTICAL CHARACTERISTICS CURVES**

(25°C Ambient Temperature Unless Otherwise Noted)

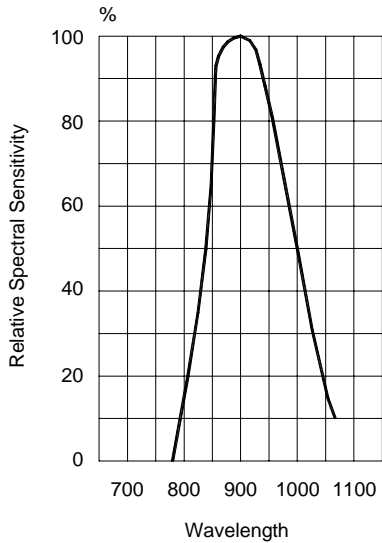

Fig.5 RELATIVE SPECTRAL SENSITIVITY VS WAVELENGTH

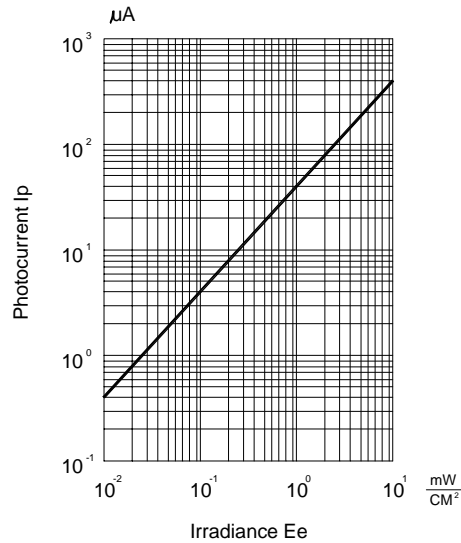

Fig.6 PHOTOCURRENT VS IRRADIANCE  $\lambda = 940 \text{ nm}$

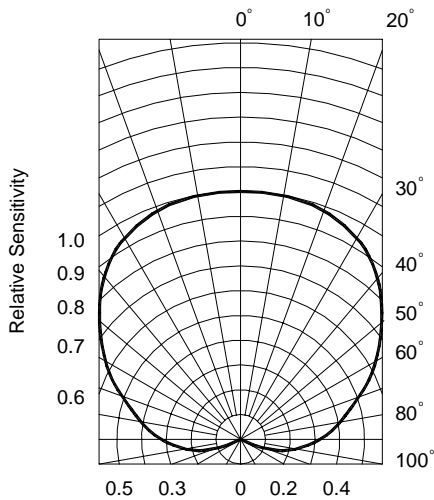

Fig.7 SENSITIVITY DIAGRAM

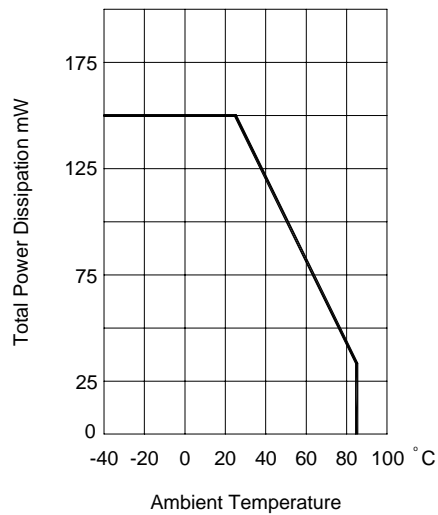

Fig.8 TOTAL POWER DISSIPATION VS AMBIENT TEMPERATURE