





### Photomicrosensor with 50- to 100-mA Switching Capacity that can be Built into Equipment

- PNP output models newly added.
- Standard, L-shaped, T-shaped, and Close-mounting: Five series of models available.
- Select from thirty output variations, including Light-ON or Dark-ON/Light-ON (selectable) models.
- Response frequency as high as 1 kHz.
- Easy operation monitoring with bright light indicator.
- Wide operating voltage range from 5 to 24 VDC.
- Models (EE-SX□□□A and EE-SX□□□R) with operation indicators that are lit when sensing objects are detected (when light is interrupted) are available.



## Ordering Information

Appearance	Sensing method	Sensing distance	Output configuration	Model		Weight
				NPN	PNP	
 Standard	Through-beam type (slot type)	5 mm (slot width)	Dark-ON/Light-ON (selectable) <sup>*1</sup>	EE-SX670 EE-SX670A <sup>*2</sup>	EE-SX670P EE-SX670R <sup>*3</sup>	Approx. 3.1 g
			Light-ON	EE-SX470	EE-SX470P	
 L-shaped			Dark-ON/Light-ON (selectable) <sup>*1</sup>	EE-SX671 EE-SX671A <sup>*2</sup>	EE-SX671P EE-SX671R <sup>*3</sup>	Approx. 3.0 g
			Light-ON	EE-SX471	EE-SX471P	
 T-shaped			Dark-ON/Light-ON (selectable) <sup>*1</sup>	EE-SX672 EE-SX672A <sup>*2</sup>	EE-SX672P EE-SX672R <sup>*3</sup>	Approx. 2.4 g
			Light-ON	EE-SX472	EE-SX472P	
 Close-mounting			Dark-ON/Light-ON (selectable) <sup>*1</sup>	EE-SX673 EE-SX673A <sup>*2</sup>	EE-SX673P EE-SX673R <sup>*3</sup>	Approx. 2.3 g
			Light-ON	EE-SX473	EE-SX473P	
 Close-mounting			Dark-ON/Light-ON (selectable) <sup>*1</sup>	EE-SX674 EE-SX674A <sup>*2</sup>	EE-SX674P EE-SX674R <sup>*3</sup>	Approx. 3.0 g
			Light-ON	EE-SX474	EE-SX474P	

**Note:** \*1. The Dark-ON/Light-ON (selectable) models can be used as Light-ON models when the L terminal and positive (+) terminal are short-circuited. An L terminal and positive (+) terminal short-circuit connector (EE-1001-1) is available.

\*2. Models with a suffix "A," such as EE-SX670A, have a Dark-ON indicator that is lit when light is interrupted.

\*3. Models with a suffix "R," such as EE-SX670R, have a Dark-ON indicator that is lit when light is interrupted.

# Application Example

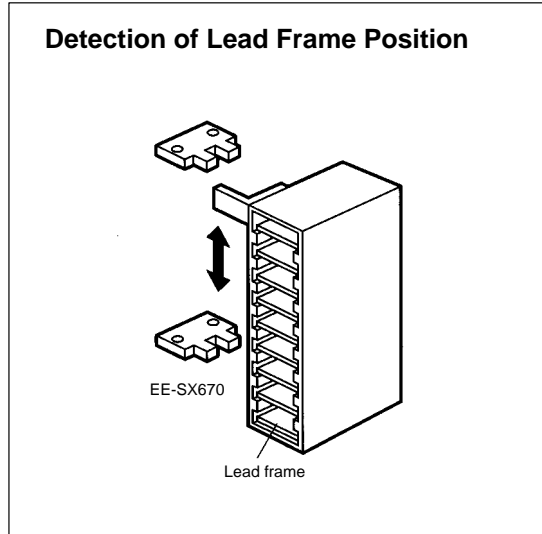

## Specifications

### ■ Ratings

Item	Output	Standard	L-shaped	T-shaped	Close-mounting	
	NPN	EE-SX670 EE-SX670A EE-SX470	EE-SX671 EE-SX671A EE-SX471	EE-SX672 EE-SX672A EE-SX472	EE-SX673 EE-SX673A EE-SX473	EE-SX674 EE-SX674A EE-SX474
	PNP	EE-SX670P EE-SX670R EE-SX470P	EE-SX671P EE-SX671R EE-SX471P	EE-SX672P EE-SX672R EE-SX472P	EE-SX673P EE-SX673R EE-SX473P	EE-SX674P EE-SX674R EE-SX474P
Sensing distance	5 mm (slot width)					
Standard sensing object	Opaque: 2 × 0.8 mm min.					
Differential travel	0.025 mm					
Light source (peak wave length)	GaAs infrared LED (940 nm)					
Receiver	Si phototransistor with a sensing wavelength of 850 nm max.					
Operation indicator (see note 1)	Operation indicator (red) lit with incident (Models with a suffix of "A" or "R" have Dark-ON indicators.)					
Power supply voltage	5 to 24 VDC ±10%, ripple (p-p): 10% max.					
Current consumption	35 mA max. (NPN), 30 mA max. (PNP)					
Control output	NPN open collector output models: At 5 to 24 VDC: 100-mA load current (I <sub>C</sub> ) with a residual voltage of 0.8 V max. 40-mA load current (I <sub>C</sub> ) with a residual voltage of 0.4 V max.  PNP open collector output models: At 5 to 24 VDC: 50-mA load current (I <sub>C</sub> ) with a residual voltage of 1.3 V max.					
Response frequency (see note 2)	1 kHz max. (3 kHz average)					

- Note:** 1. The indicator is GaP red LED (peak emission wavelength: 690 nm).  
 2. The response frequency was measured by detecting the following rotating disks.

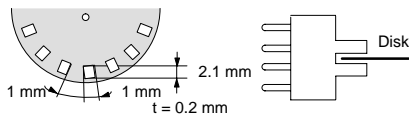

■ Characteristics

Item	Output	Standard	L-shaped	T-shaped	Close-mounting	
	NPN	EE-SX670 EE-SX670A EE-SX470	EE-SX671 EE-SX671A EE-SX471	EE-SX672 EE-SX672A EE-SX472	EE-SX673 EE-SX673A EE-SX473	EE-SX674 EE-SX674A EE-SX474
	PNP	EE-SX670P EE-SX670R EE-SX470P	EE-SX671P EE-SX671R EE-SX471P	EE-SX672P EE-SX672R EE-SX472P	EE-SX673P EE-SX673R EE-SX473P	EE-SX674P EE-SX674R EE-SX474P
Ambient illumination (on Receiver lens)	Fluorescent light: 1,000 lx max.					
Ambient temperature	Operating: -25° to 55°C Storage: -30° to 80°C					
Ambient humidity	Operating: 5% to 85% Storage: 5% to 95%					
Vibration resistance	Destruction: 20 to 2,000 Hz, (with a peak acceleration of 10G), 1.5-mm double amplitude for 2 hrs (with 4-minute cycles) each in X, Y, and Z directions					
Shock resistance	Destruction: 500 m/s <sup>2</sup> (approx. 50G) for 3 times each in X, Y, and Z directions					
Degree of protection	IEC60529 IP50					
Connection method	Connector type (direct soldering possible)					
Weight	Approx. 3.1 g	Approx. 3.0 g	Approx. 2.4 g	Approx. 2.3 g	Approx. 3.0 g	
Material	Case: Polybutylene phthalate (PBT), Cover: Polycarbonate (PC), Emitter/receiver: Polycarbonate (PC)					

Engineering Data

Sensing Position Characteristics (Typical)

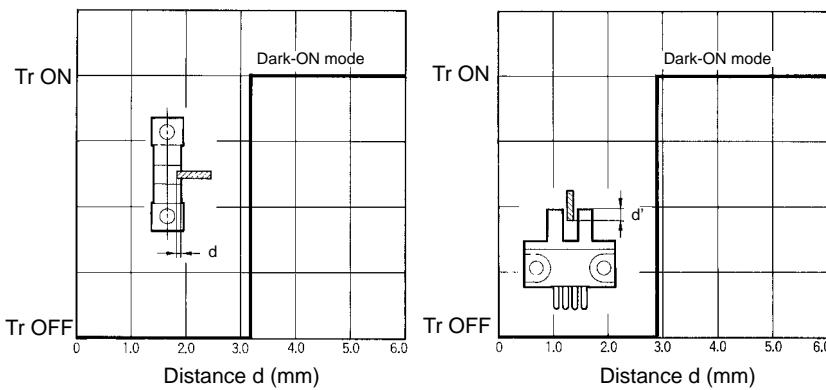

Repeated Sensing Position Characteristics (Typical)

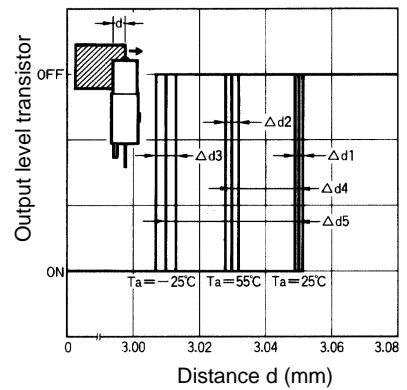

V<sub>CC</sub> = 12 V  
 No. of repetitions: 20  
 Δd1 = 0.002 mm  
 Δd2 = 0.004 mm  
 Δd3 = 0.005 mm  
 Δd4 = 0.02 mm  
 Δd5 = 0.04 mm

# Operation

## ■ Output Circuit Diagrams

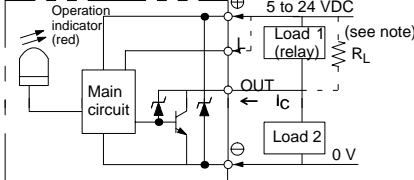
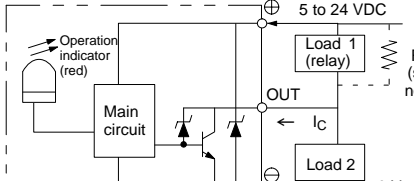
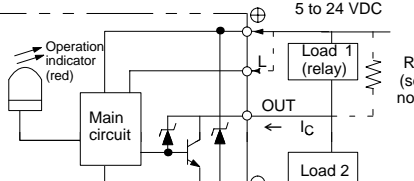
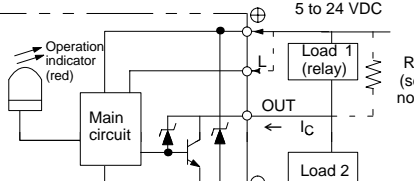
Output configuration	Model	Output transistor operation	Timing Charts	Output Circuit
NPN Output	EE-SX670 EE-SX671 EE-SX672 EE-SX673 EE-SX674	Light-ON	(When terminals L and ⊕ are short-circuited) Incident Interrupted Operation indicator (red) ON OFF Output transistor ON OFF Load 1 (relay) Operates Releases Load 2 H L	 <p><b>Note:</b> When using on voltage output, always insert a resistor in RL.</p>
		Dark-ON	(When terminals L and ⊕ are open) Incident Interrupted Operation indicator (red) ON OFF Output transistor ON OFF Load 1 (relay) Operates Releases Load 2 H L	
	EE-SX470 EE-SX471 EE-SX472 EE-SX473 EE-SX474	Light-ON	Incident Interrupted Operation indicator (red) ON OFF Output transistor ON OFF Load 1 (relay) Operates Releases Load 2 H L	 <p><b>Note:</b> When using on voltage output, always insert a resistor in RL.</p>
		Dark-ON	(When terminals L and ⊕ are open) Incident Interrupted Operation indicator (red) ON OFF Output transistor ON OFF Load 1 (relay) Operates Releases Load 2 H L	 <p><b>Note:</b> When using on voltage output, always insert a resistor in RL.</p>
	EE-SX670A EE-SX671A EE-SX672A EE-SX673A EE-SX674A	Light-ON	(When terminals L and ⊕ are short-circuited) Incident Interrupted Operation indicator (red) ON OFF Output transistor ON OFF Load 1 (relay) Operates Releases Load 2 H L	 <p><b>Note:</b> When using on voltage output, always insert a resistor in RL.</p>
		Dark-ON	(When terminals L and ⊕ are open) Incident Interrupted Operation indicator (red) ON OFF Output transistor ON OFF Load 1 (relay) Operates Releases Load 2 H L	

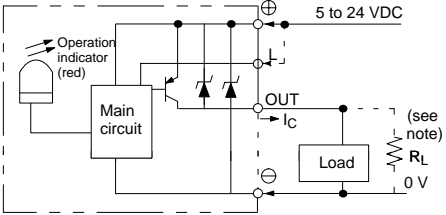
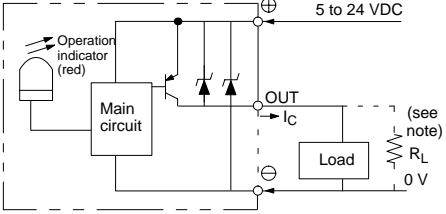
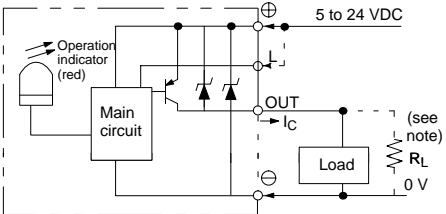
Output configuration	Model	Output transistor operation	Timing Charts	Output Circuit
PNP Output	EE-SX670P EE-SX671P EE-SX672P EE-SX673P EE-SX674P	Light-ON	(When terminals L and ⊕ are short-circuited)  Incident Interrupted Operation indicator (red) ON OFF Output transistor ON OFF Load (relay) Operates Releases Voltage output H L	 <p><b>Note:</b> When using on voltage output, always insert a resistor in RL.</p>
		Dark-ON	(When terminals L and ⊕ are open)  Incident Interrupted Operation indicator (red) ON OFF Output transistor ON OFF Load 1 (relay) Operates Releases Load 2 H L	
	EE-SX470P EE-SX471P EE-SX472P EE-SX473P EE-SX474P	Light-ON	(When terminals L and ⊕ are short-circuited)  Incident Interrupted Operation indicator (red) ON OFF Output transistor ON OFF Load (relay) Operates Releases Voltage output H L	 <p><b>Note:</b> When using on voltage output, always insert a resistor in RL.</p>
	EE-SX670R EE-SX671R EE-SX672R EE-SX673R EE-SX674R	Light-ON	(When terminals L and ⊕ are short-circuited)  Incident Interrupted Operation indicator (red) ON OFF Output transistor ON OFF Load (relay) Operates Releases Voltage output H L	 <p><b>Note:</b> When using on voltage output, always insert a resistor in RL.</p>
		Dark-ON	(When terminals L and ⊕ are open)  Incident Interrupted Operation indicator (red) ON OFF Output transistor ON OFF Load (relay) Operates Releases Voltage output H L	

# Dimensions

**Note:** All units are in millimeters unless otherwise indicated.

EE-SX670/670P  
 EE-SX670A/670R  
 EE-SX470/470P

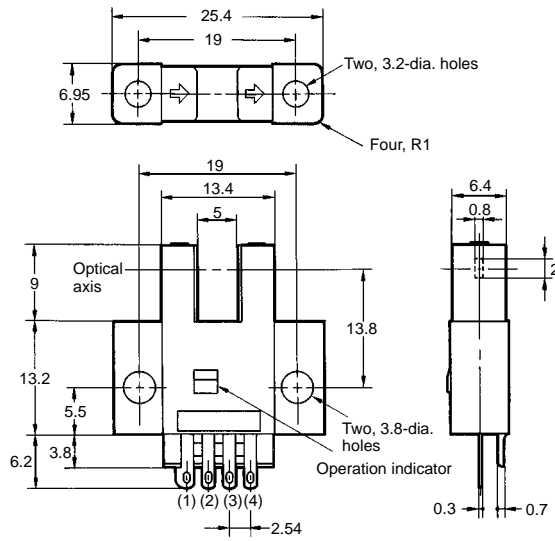
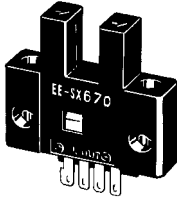

**Terminal Arrangement**

(1)	⊕	Vcc
(2)	L	L (see note)
(3)	OUT	OUT PUT
(4)	⊖	GND (0 V)

**Note:** Not used in EE-SX470

EE-SX671/671P  
 EE-SX671A/671R  
 EE-SX471/471P

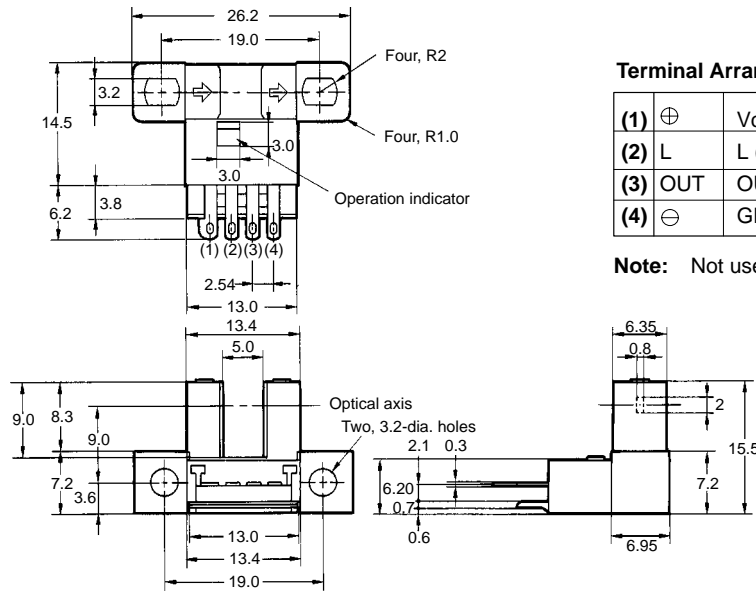
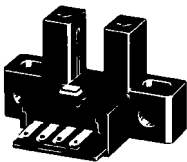

**Terminal Arrangement**

(1)	⊕	Vcc
(2)	L	L (see note)
(3)	OUT	OUT PUT
(4)	⊖	GND (0 V)

**Note:** Not used in EE-SX471

EE-SX672/672P  
 EE-SX672A/672R  
 EE-SX472/472P

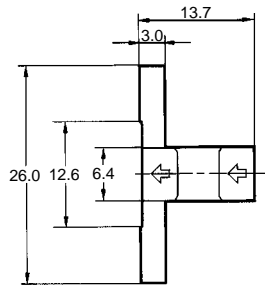
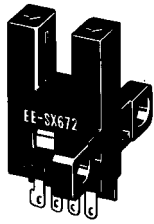

**Terminal Arrangement**

(1)	⊕	Vcc
(2)	L	L (see note)
(3)	OUT	OUT PUT
(4)	⊖	GND (0 V)

**Note:** Not used in EE-SX472

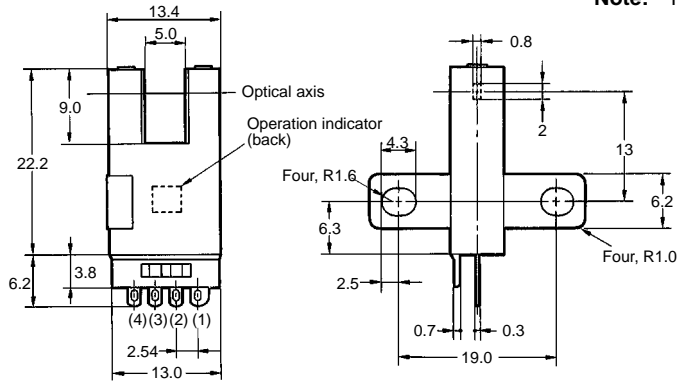

EE-SX673/673P  
 EE-SX673A/673R  
 EE-SX473/473P

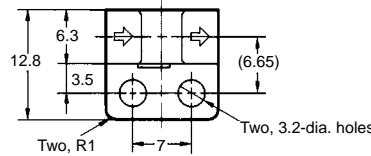

**Terminal Arrangement**

(1)	⊕	Vcc
(2)	L	L (see note)
(3)	OUT	OUT PUT
(4)	⊖	GND (0 V)

**Note:** Not used in EE-SX473

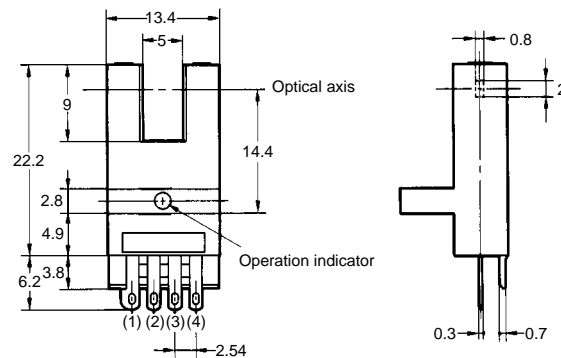

EE-SX674/674P  
 EE-SX674A/674R  
 EE-SX474/474P

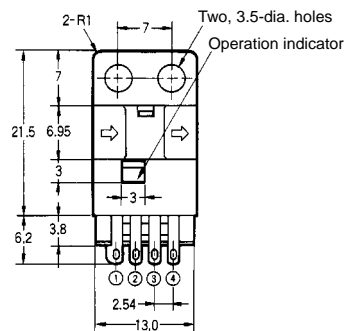
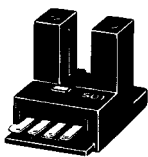

**Terminal Arrangement**

(1)	⊕	Vcc
(2)	L	L (see note)
(3)	OUT	OUT PUT
(4)	⊖	GND (0 V)

**Note:** Not used in EE-SX474

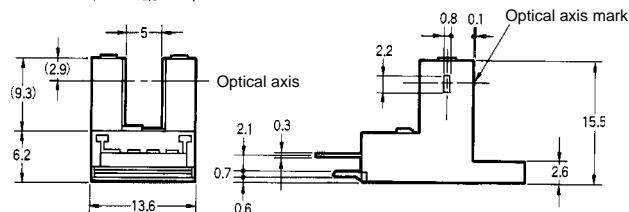

# Precautions

Do not use the EE-SX at voltage exceeding the rated voltage range, otherwise the EE-SX may be damaged.

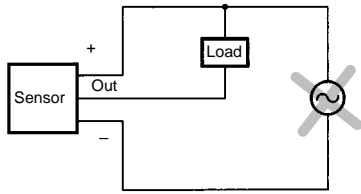

Do not make mistakes in wiring, such as mistakes in polarity, otherwise the EE-SX may be damaged.

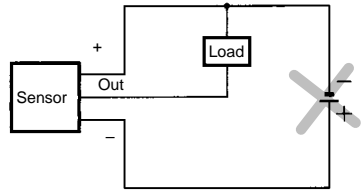

Do not short-circuit the load (i.e., do not connect a power supply directly to the Sensor) as shown below, otherwise the EE-SX may be damaged.

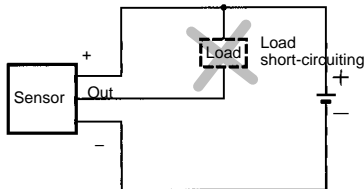

## Caution

### Mounting

The EE-SX is a Sensor to be built into equipment. Therefore, no special protective measures have been taken to protect the EE-SX from external light disturbance. Make sure that the EE-SX is not affected by incandescent lamps or other light sources that may cause external light disturbance, otherwise the EE-SX may malfunction.

Be sure to mount the Sensor securely to flat plates. The characteristics of the Through-beam Sensor change if the slot is deformed.

Use M3.0 screws when mounting the EE-SX. Be sure to use spring washers with the screws so that the screws will not loosen. The tightening torque applied to each screw must be no more than 0.59 N • m (6 kgf • cm).

Make sure that nothing will come into contact with the sensing element of the Sensor. If the sensing element has scratch damage, the characteristics of the Sensor will decrease.

Make sure that the EE-SX is securely mounted and not loosened by vibration or shock.

### Wiring

#### Countermeasures Against Surge

If the power supply has surge voltage, connect a Zener diode with standing 30 to 35 V or 0.1 to 1-μF capacitor in parallel to the power supply to absorb the surge voltage.

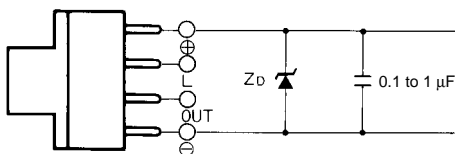

If the load is a relay or other small inductive load, connect the load to the EE-SX as shown below. Be sure to connect a diode for counter-voltage absorption.

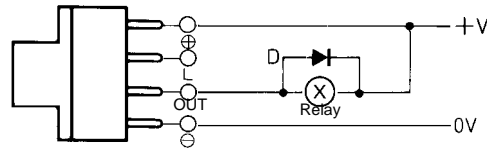

Do not wire power lines or high-tension lines alongside the lines of the EE-SX in the same conduit, otherwise the EE-SX may be damaged or malfunction due to induction. Be sure to wire the lines of the EE-SX separately from power lines or high-tension lines or lay them in an exclusive, shielded conduit.

### Voltage Output

A Sensor with open collector output can be connected to a device with voltage-input specifications by connecting a resistor between the power supply and output terminals as shown in the following circuit diagram. The resistance of the resistor is normally 4.7 kΩ and must withstand a power of 0.5 W at 24 V and 0.25 W at 12 V.

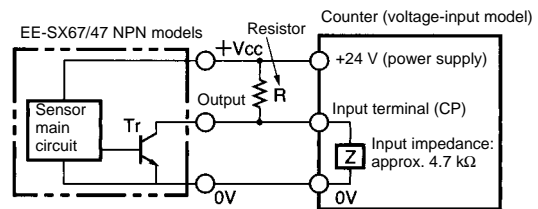

EE-SX47/67 NPN Models with a 4.7-kΩ Resistor

High level:

$$\text{Input voltage } (V_H) = \frac{Z}{R+Z} V_{CC} = \frac{4.7 \text{ k}}{4.7 \text{ k} + 4.7 \text{ k}} \times 24 \text{ V} = 12 \text{ V}$$

Low level:

$$\text{Input voltage } (V_L) \leq 0.4 \text{ V}$$

$$\text{Load current } (I_C) = \frac{V_{CC}}{R} = \frac{24 \text{ V}}{4.7 \text{ k}} = 5.1 \text{ mA} \leq 50 \text{ to } 100 \text{ mA}$$

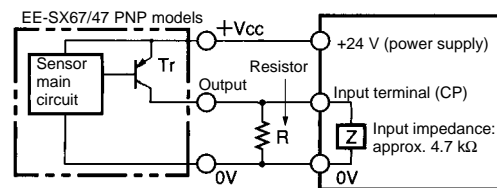

EE-SX47/67 PNP Models with a 4.7-kΩ Resistor

High level:

$$\text{Input voltage } (V_H) = V_{CC} - \text{residual voltage} \approx 24 \text{ V} - 1.3 \text{ V} = 22.7 \text{ V}$$

Low level:

$$\text{Input voltage } (V_L) \approx 0 \text{ V}$$

**Note:** Refer to the ratings of the Sensor for the relationship between the residual voltage and load current.



**Others**

Do not wire the EE-SX while power is applied, otherwise the EE-SX may be damaged.

Do not install the EE-SX in the following locations, otherwise the EE-SX may be damaged or malfunction.

Locations with excessive dust

Locations with corrosive gas

Locations where water, oil, or chemical is directly sprayed



Outdoors or locations exposed to direct sunlight

Make sure that the operating ambient temperature is within the rated range.

The Sensor may be soluble in organic solvent, acid, and alkaline, aromatic hydrocarbon, and chlorinated aliphatic hydrocarbon solvents. The characteristics of the Sensor may decrease as a result. Therefore, make sure that the Sensor is free from these solutions.

## ■ Additional Models (EE-SX77/87)

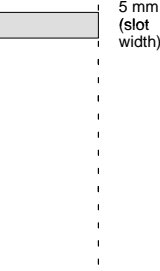
## Ordering Information

Appearance	Sensing method	Sensing distance	Output configuration	Model	
				NPN	PNP
	Through-beam (slot)		Dark ON	EE-SX770	EE-SX770P
				EE-SX770A	EE-SX770R
			Light ON	EE-SX870	EE-SX870P
				EE-SX870A	EE-SX870R
			Dark ON	EE-SX771	EE-SX771P
				EE-SX771A	EE-SX771R
			Light ON	EE-SX871	EE-SX871P
				EE-SX871A	EE-SX871R
			Dark ON	EE-SX772	EE-SX772P
				EE-SX772A	EE-SX772R
			Light ON	EE-SX872	EE-SX872P
				EE-SX872A	EE-SX872R

## Specifications



### ■ Ratings/Characteristics

Item	Through-beam models(slot)							
	Dark ON				Light ON			
	NPN		PNP		NPN		PNP	
Output configuration								
Output								
Model	EE-SX770 EE-SX771 EE-SX772	EE-SX770A EE-SX771A EE-SX772A	EE-SX770P EE-SX771P EE-SX772P	EE-SX770R EE-SX771R EE-SX772R	EE-SX870 EE-SX871 EE-SX872	EE-SX870A EE-SX871A EE-SX872A	EE-SX870P EE-SX871P EE-SX872P	EE-SX870R EE-SX871R EE-SX872R
Sensing distance	5 mm (slot width)							
Standard sensing object	Opaque: 2 x 0.8 mm min							
Operation indicator (see note)	Operation indicator (red) lit with incident (Models with a suffix of "A" or "R" have Dark-ON indicators.)							
Power supply voltage	5 to 24 VDC ± 10%, ripple (p-p): 10% max.							
Current consumption	35 mA max. (NPN), 30 mA max. (PNP)							
Control output	NPN open collector output models: At 5 to 24 VDC: 100-mA load current (I <sub>C</sub> ) with a residual voltage of 0.8 V max. 40-mA load current (I <sub>C</sub> ) with a residual voltage of 0.4 V max.  PNP open collector output models: At 5 to 24 VDC: 50-mA load current (I <sub>C</sub> ) with a residual voltage of 1.3 V max.							
Ambient illuminance	Sensing surface: 1,000 ℓx max. with fluorescent light							
Ambient temperature	Operating: -25°C to 55°C Storage: -30°C to 80°C							
Ambient humidity	Operating: 5% to 85% Storage: 5% to 95%							
Degree of protection	IEC60529 IP60							
Connection method (standard length)	Pre-wired: 2 m							
Weight	Approx. 20 g							

**Note:** The indicator is GaP red LED (peak emission wavelength: 690 nm).

# Operation

## ■ Output Circuits

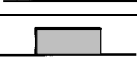
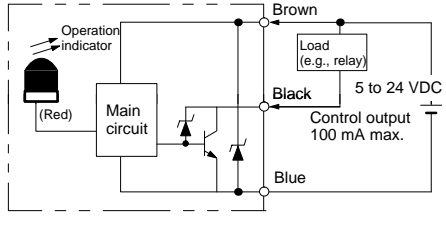
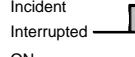
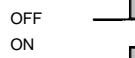
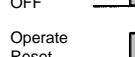
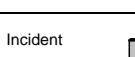
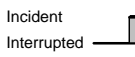
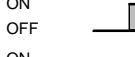
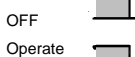
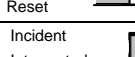
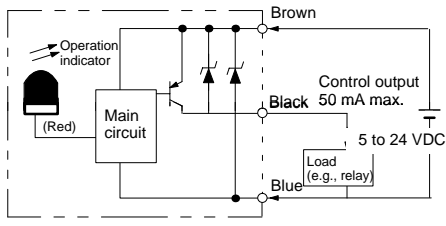
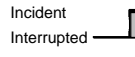
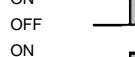
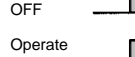
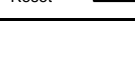
Output configuration	Model	Output transistor operation	Timing Charts	Output Circuit
NPN Output	EE-SX770 EE-SX771 EE-SX772 EE-SX770A EE-SX771A EE-SX772A	Dark-ON	Incident Interrupted  Operation indicator (red) ON OFF  Output transistor ON OFF  Load (e.g., relay) Operate Reset 	
	EE-SX870 EE-SX871 EE-SX872 EE-SX870A EE-SX871A EE-SX872A	Light-ON	Incident Interrupted  Operation indicator (red) ON OFF  Output transistor ON OFF  Load (e.g., relay) Operate Reset 	
PNP Output	EE-SX770P EE-SX771P EE-SX772P EE-SX770R EE-SX771R EE-SX772R	Dark-ON	Incident Interrupted  Operation indicator (red) ON OFF  Output transistor ON OFF  Load (e.g., relay) Operate Reset 	
	EE-SX870P EE-SX871P EE-SX872P EE-SX870R EE-SX871R EE-SX872R	Light-ON	Incident Interrupted  Operation indicator (red) ON OFF  Output transistor ON OFF  Load (e.g., relay) Operate Reset 	

**■ Notice**

**Photomicrosensors (EE-SX67/47, 77/87 models) and Connectors (EE-1001/1001-1/1006/1009/1010/1010-R) have been certified as products that conform to the following UL Standard.**

Certified Date: February 9, 1998  
Certified Models: All OMRON EE-SX67/47-series Photomicrosensors and the Photomicrosensor Connectors (EE-1001/1001-1/1006/1009/1010/1010-R)  
File No.: E41515  
Standard Name: UL508: industrial control devices  
Certification Method: UL Recognition (recognition certification for products used in the U.S.A.) and Canadian UL Recognition (recognition certification for products used in Canada)  
Applicable Lot No.: 928 and after (products manufactured on and after February 9, 1998)

**The following Photomicrosensors have been certified as products conforming to the EMC Directives (CE marking).**

CE Marking Date: April 1, 1998  
Applicable Models: All EE-SX67/47 (A) models, EE-SX67/47 P, R models  
All EE-SX77/87 (A) models, EE-SX77/87 P, R models  
EE-SY671/672  
EE-SPW311/411  
EE-SPY311/312  
EE-SPY301/302  
EE-SPY401/402  
EE-SPY411/412  
EE-SPX302/304/306-W2A  
EE-SPX402/404/406-W2A  
EE-SPX303/403  
EE-SPX301/401

**ALL DIMENSIONS SHOWN ARE IN MILLIMETERS.**

To convert millimeters into inches, multiply by 0.03937. To convert grams into ounces, multiply by 0.03527.

Cat. No. E303-E1-1 **In the interest of product improvement, specifications are subject to change without notice.**

**OMRON Corporation**

Industrial Sensors Division  
Sensing Devices and Components Division H.Q.  
28th Fl., Crystal Tower Bldg.,  
1-2-27, Shiromi, Chuo-ku,  
Osaka 540-6028 Japan  
Phone: (81)6-949-6012 Fax: (81)6-949-6021

Printed in Japan  
0898-4M (0898) Ⓐ