



## Technical Data Sheet

# Infrared Remote-control Receiver Module

### IRM-26xxA SERIES

#### Features :

- Photo detector and preamplifier in one package
- Internal filter for PCM frequency
- Improved shielding against electrical field disturbance
- TTL and CMOS compatibility
- Output active low
- Low power consumption
- Improved immunity against ambient light
- Pb free
- The product itself will remain within RoHS compliant version.



#### Descriptions

- The IRM-26xxA SERIES are miniaturized receivers for infrared remote control systems. PIN diode and preamplifier are assembled on lead frame, the epoxy package is designed as IR filter. The demodulated output signal can directly be decoded by a microprocessor. IRM-26xxA SERIES is the standard IR remote control receiver series, supporting all major transmission codes.

#### Applications

1. Optical switch
2. Light detecting portion of remote control
  - AV instruments such as Audio, TV, VCR, CD, MD, etc.
  - Home appliances such as Air-conditioner, Fan , etc.
  - The other equipments with wireless remote control.
  - CATV set top boxes
  - Multi-media Equipment

PART	MATERIAL	COLOR
Chip	Silicon	Black
Compound	Epoxy	Black



---

**IRM-26xxA SERIES**
**Absolute Maximum Ratings (Ta=25°C)**

Parameter	Symbol	Rating	Unit	Notice
Supply Voltage	Vcc	0~6	V	
Operating Temperature	Topr	-25 ~ +80	°C	
Storage Temperature	Tstg	-40 ~ +85	°C	
Soldering Temperature	Tsol	260	°C	4mm from mold body less than 10 seconds

**Recommended Operating Condition**
**Supply Voltage Rating: Vcc 4.5V to 5.5V**
**Electro-Optical Characteristics (Ta=25°C, and Vcc=5 V)**

Parameter	Symbol	MIN.	TYP.	MAX.	Unit	Condition
Consumption Current	Icc	---	1.1	2.5	mA	No signal input
Peak Wavelength	$\lambda_p$	---	940	---	nm	
Reception Distance	L <sub>0</sub>	12	---	---	m	At the ray axis *1
	L <sub>45</sub>	6	---	---		
Half Angle(Horizontal)	$\Theta_h$	---	45	---	deg	
Half Angle(Vertical)	$\Theta_v$	---	45	---	deg	
High Level Pulse Width	T <sub>H</sub>	400	---	800	$\mu$ s	
Low Level Pulse Width	T <sub>L</sub>	400	---	800	$\mu$ s	
High Level Output Voltage	V <sub>H</sub>	4.5	---	---	V	
Low Level Output Voltage	V <sub>L</sub>	---	0.2	0.5	V	

\*1:The ray receiving surface at a vertex and relation to the ray axis in the range of  $\theta=0^\circ$  and  $\theta=45^\circ$ .

\*2:A range from 30cm to the arrival distance. Average value of 50 pulses.

**IRM-26xxA SERIES**

**Test Method :**

The specified electro-optical characteristics is satisfied under the following Conditions at the controllable distance.

①Measurement place

A place that is nothing of extreme light reflected in the room.

②External light

Project the light of ordinary white fluorescent lamps which are not high frequency lamps and must be less than 10 Lux at the module surface.  
( $E_e \leq 10\text{Lux}$ )

③Standard transmitter

A transmitter whose output is so adjusted as to  $V_o=400\text{mVp-p}$  and the output Wave form shown in Fig.-1. According to the measurement method shown in Fig.-2 the standard transmitter is specified.

However , the infrared photodiode to be used for the transmitter should be  $\lambda_p=940\text{nm}, \Delta\lambda=50\text{nm}$ . Also, photodiode is used of PD438B( $V_r=5\text{V}$ ).

④Measuring system

According to the measuring system shown in Fig.-3

Fig.-1 Transmitter Wave Form

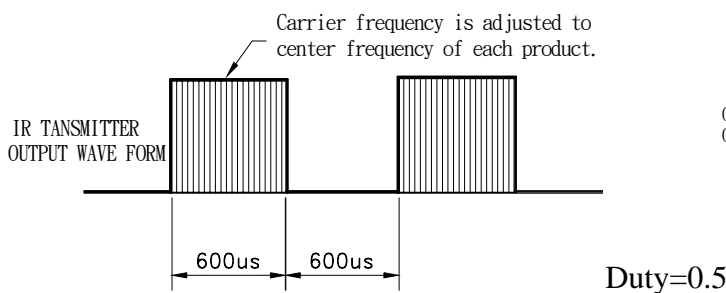

D.U.T output Pulse

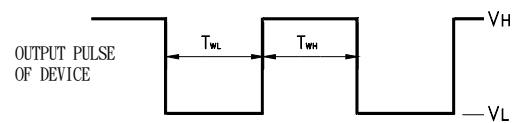

**IRM-26xxA SERIES**

Fig.-2 Measuring Method

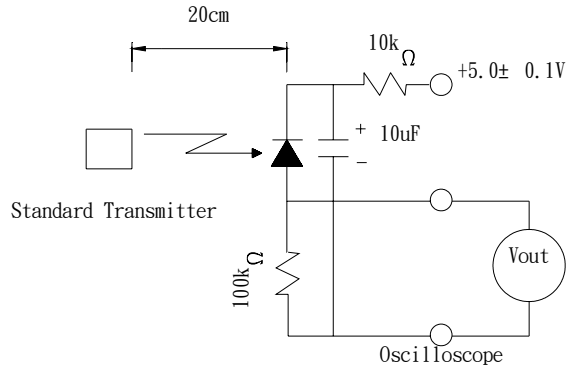
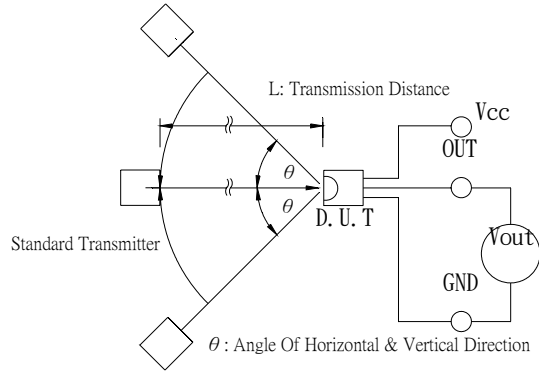
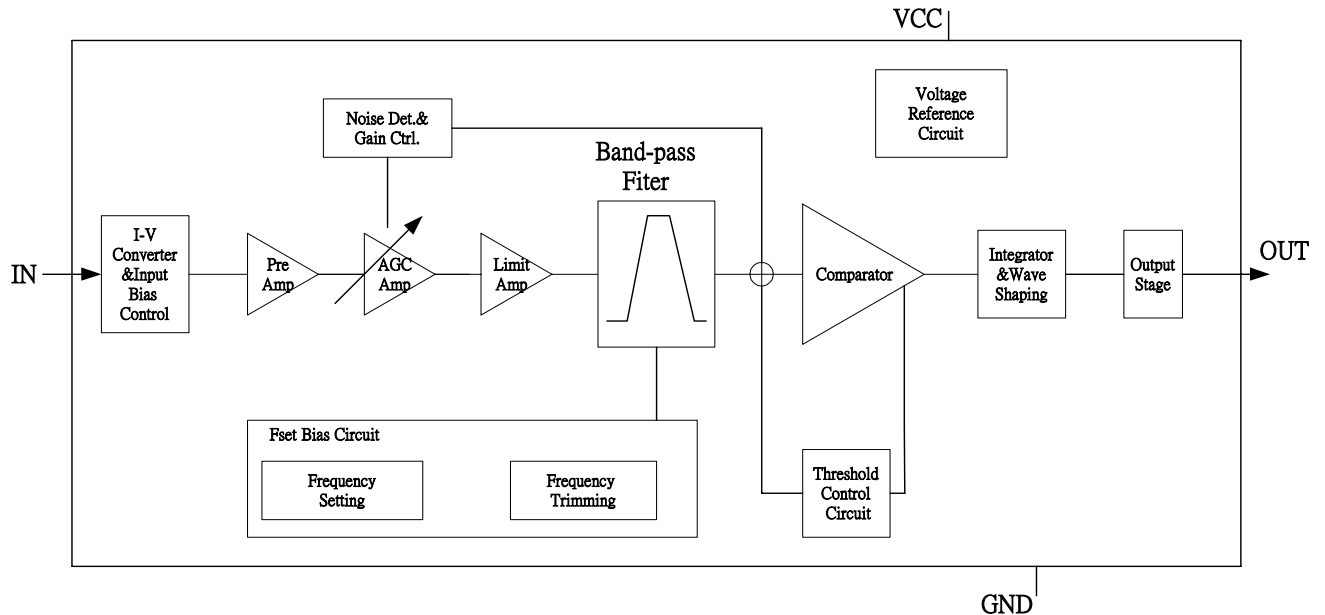

Fig.-3 Measuring System



**Block Diagram :**



**Application Circuit :**

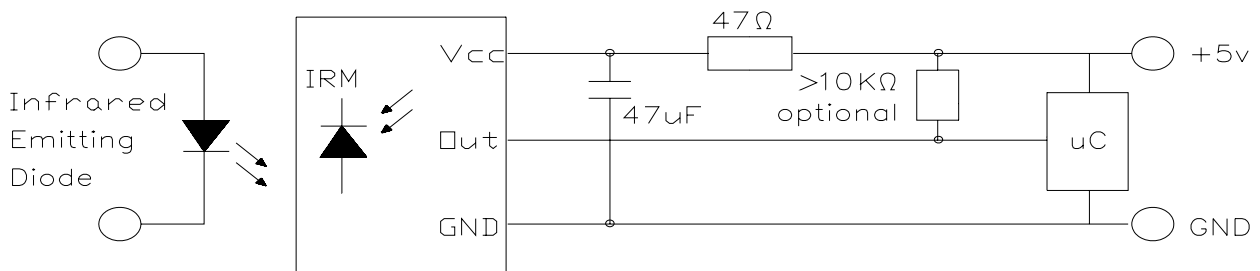

RC Filter should be connected closely between Vcc pin and GND pin.

**IRM-26xxA SERIES**

**The Notice of Application:**

Transmission o remote control signal consist of four parts: Encode Part, IR Transmitter Source, IRM device, Decode Part

1. When IRM-26xxA code select frequency, it need to well understand the center system of encode part.
2. Strong or weak light of IR Transmitter can affect distance of transmission.
3. When using IRM-26xxA device, it requires the composition of code pattern to reach the demand as follows:

Minimum Burst Length tburst (number of pulses per burst) : 10 cycles

Minimum data pause time:

Remocon Tx code with Full frame Repeat

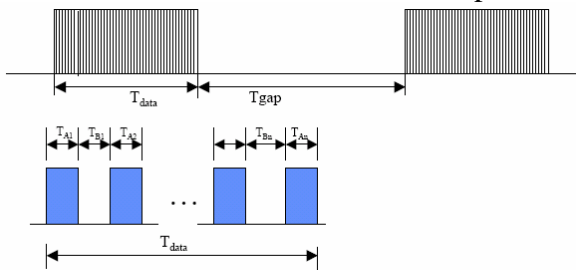

Remocon TX code with Repeat key



Remocon TX repeat Code with minimum burst length



$$T_{actual,data} = T_{data} - \sum_n (T_{Bn} - 150\mu s)$$

$$T_{actual,gap} = T_{gap} - \sum_n (T_{Bn} - 150\mu s)$$

$$T_{actual,gap} \geq 2.0 * T_{actual,data}$$

$$T_{gap} \geq 2.0 * (T_r + 150\mu s)$$

4. It needs to ensure the translation range of decode part if it is applied to the pulse-width range.

If the above items hardly assure of its application, it'll cause NG(no good) message from the edge of signal.

**IRM-26xxA SERIES**

**Typical Electro-Optical Characteristics Curves**

Fig.-4 Relative Spectral Sensitivity vs. Wavelength

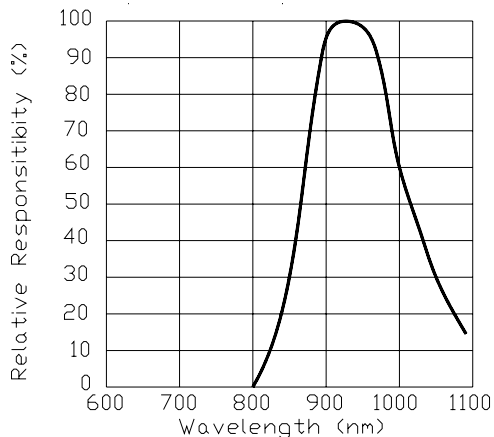

Fig.-5 Relative Transmission Distance vs. Direction

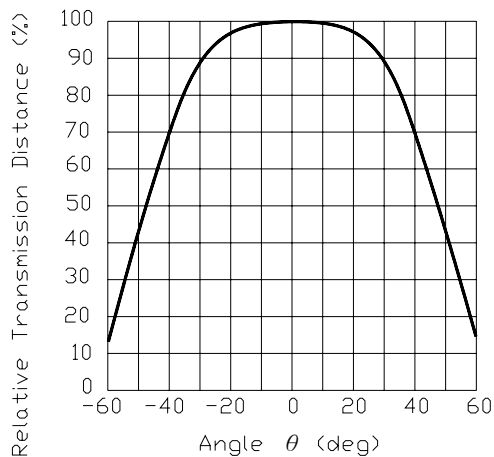

Fig.-6 Arrival Distance vs. Ambient Temperature

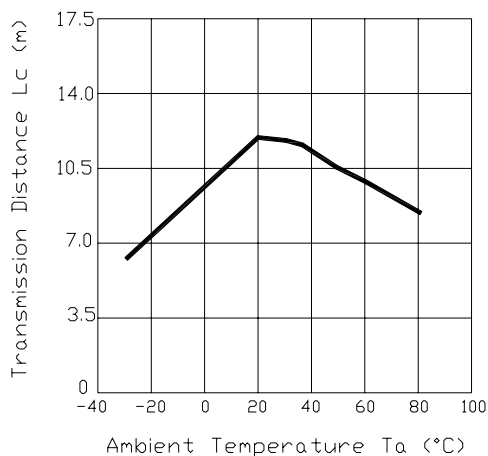

Fig.-7 Arrival Distance vs. Supply Voltage

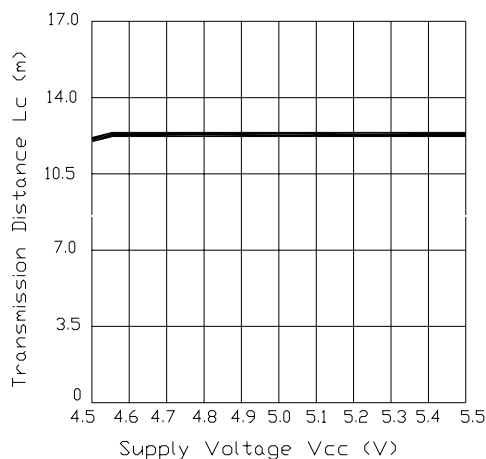
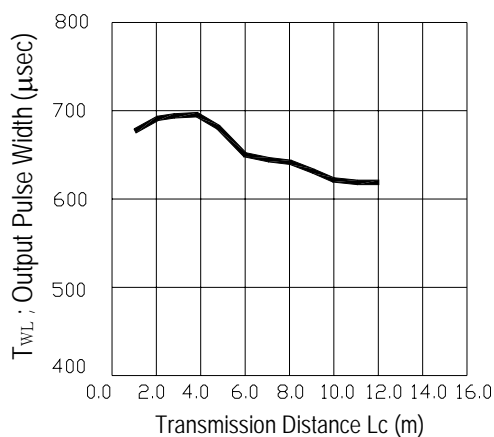
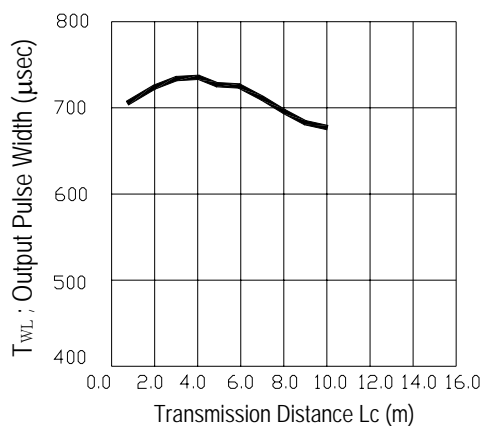

Fig.-8 Relative Transmission Distance vs. Center Carrier Frequency

IRM-2633A, 2636A, 2638A, 2640A



IRM-2656A



**IRM-26xxA SERIES**

**Typical Electro-Optical Characteristics Curves**

Fig.-9 Relative Transmission Distance vs. Center Carrier Frequency

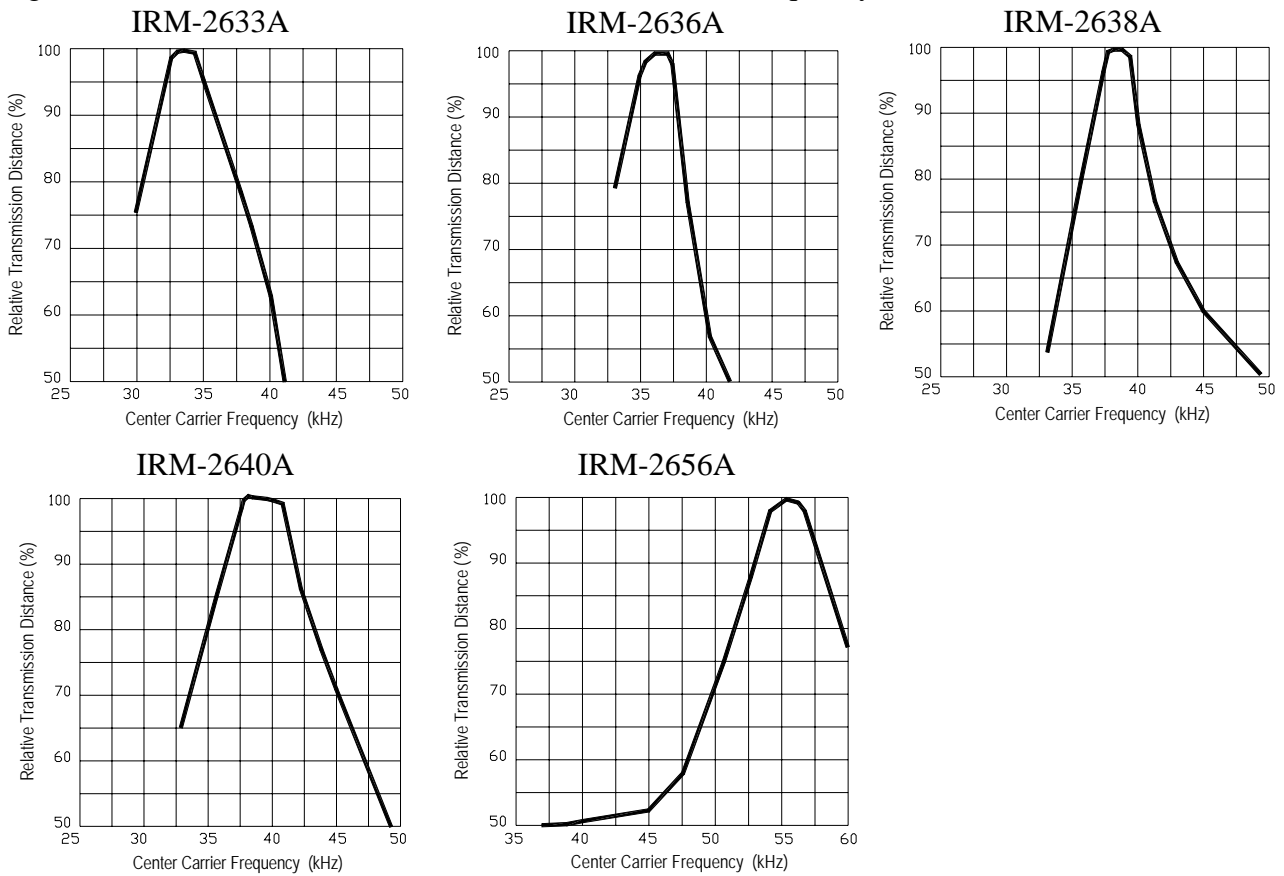



**■ Reliability Test Item And Condition**

The reliability of products shall be satisfied with items listed below.

Confidence level: 90%



LTPD: 10%

Test Items	Test Conditions	Failure Judgement Criteria	Samples(n) Defective(c)
Temperature cycle	1 cycle -40°C +25°C +85°C (30min)(5min)(30min) 300 cycle test	$L0 \leq L \times 0.8$ $L45 \leq L \times 0.8$  L: Lower specification limit	n=22,c=0
High temperature test	Temp: +85°C Vcc:5V 1000hrs		n=22,c=0
Low temperature storage	Temp: -40°C 1000hrs		n=22,c=0
High temperature High humidity	Ta: 85°C ,RH: 85% 1000hrs		n=22,c=0
Solder heat	Temp: 260±5°C 10sec 4mm From the bottom of the package.		n=22,c=0

**Packing Quantity Specification**

1. 1500PCS/1Box
2. 10Boxes/1Carton

**Label Form Specification**

<b>EVERLIGHT</b>	
CPN:	
P/N:	
	<b>RoHS</b>
IRM-2638A	
QTY:	CAT:
	HUE:
LOT NO:	REF:
	
MADE IN TAIWAN	

PN: Customer's Production Number  
P/N : Production Number  
QTY: Packing Quantity  
CAT: Ranks  
HUE: Peak Wavelength  
REF: Reference  
LOT No: Lot Number  
MADE IN TAIWAN: Production Place

**Notes**

1. Above specification may be changed without notice. EVERLIGHT will reserve authority on material change for above specification.
2. When using this product, please observe the absolute maximum ratings and the instructions for using outlined in these specification sheets. EVERLIGHT assumes no responsibility for any damage resulting from use of the product which does not comply with the absolute maximum ratings and the instructions included in these specification sheets.
3. These specification sheets include materials protected under copyright of EVERLIGHT corporation. Please don't reproduce or cause anyone to reproduce them without EVERLIGHT's consent.

**EVERLIGHT ELECTRONICS CO., LTD.**  
Office: No 25, Lane 76, Sec 3, Chung Yang Rd,  
Tucheng, Taipei 236, Taiwan, R.O.C

Tel: 886-2-2267-2000, 2267-9936  
Fax: 886-2267-6244, 2267-6189, 2267-6306  
<http://www.everlight.com>