

MODEL 8140 SERIES

7/8" Diameter

10-Turn* Hybrid

Precision Potentiometer / Position Sensor



MODEL STYLES

8141	1/8" Shaft, 1/4" Bushing
8143	1/8" Shaft, Servo
8146	1/4" Shaft, 3/8" Bushing
8148 (for heavy side load applications) NEW PRODUCT	1/4" Shaft, 3/8" Bushing

ELECTRICAL

Resistance Range, Ohms	1K to 100K
Standard Resistance Tolerance	±10%
Minimum Practical Resistance Tolerance	±5%
Independent Linearity	±0.25%
Power Rating, Watts	2.0 at 70°C derating to 0 at 125°C
Dielectric Strength	1,000V rms
Insulation Resistance, Minimum	1,000 Megohms
Output Smoothness, Maximum	0.05%≤5K Ohms, 0.03%>5K Ohms
Actual Electrical Travel, Nominal	3600°
Tap Tolerance (Voltage Tap Only)	±0.05% of input voltage
End Voltage, Maximum	0.2% of input voltage
Resolution	Essentially Infinite
Temperature Coefficient	+100ppm/°C, -150ppm/°C

ENVIRONMENTAL (MIL-R-12934)

Operating Temperature Range	Static: -55°C to +125°C Dynamic: -40°C to +125°C
Temperature Cycling	5 cycles, -40°C to +125°C (5% ΔR)
Shock, 6ms Sawtooth	100G's (0.1ms discontinuity max.)
Vibration	15G's, 10 to 2,000 Hz (5% ΔR, 0.1ms discontinuity max.)
Moisture Resistance	Five 24 hour cycles (3% ΔR)
High Temperature Exposure	1,000 hours at 125°C (5% ΔR)
Rotational Load Life	5 mil. shaft rev. + 900 hrs. at rated wattage at 70°C (5% ΔR)
Rotational Life Model 8148 (1 pound Side Load)	5 mil. shaft rev. + 900 hrs. at rated wattage at 70°C (5% ΔR)

Specifications subject to change without notice.

* Model available in 3 & 5 turn versions.

MECHANICAL

Total Mechanical Travel		3600° + 15° - 0°
Number of Gangs, Maximum		2
Weight, Nominal (single gang)		0.75 oz.
Backlash, Maximum		1°
	8141, 8146	8143
Static Stop Strength	60 oz.-in.	36 oz.-in.
Panel Nut Tightening Torque, Maximum	25 lb.-in.	NA
Shaft End Play, Maximum	.010"	.005"
Shaft Runout, T.I.R., Maximum	.003"	.002"
Pilot Diameter Runout, T.I.R., Maximum	.004"	.002"
Lateral Runout, T.I.R., Maximum	.005"	.004"
Shaft Radial Play, Maximum	.003"	.002"
Start/Run Torque, Maximum (per gang)	0.8 oz.-in.	0.6 oz.-in.

STANDARD RESISTANCE VALUES, OHMS

1K	2K	5K	10K	20K	50K	100K
----	----	----	-----	-----	-----	------

METRIC CONVERSIONS

1 in.	25.4 mm	1 oz.-in.	0,007 N-m
1 oz.	28.4 gm	1 lb.-in.	0,113 N-m

OUTLINE DIMENSIONS (Inch/mm)

Models 8141 & 8146
Bushing Mount with Sleeve Bearing

Dim.	8141	8146
A	$\frac{.688 \pm .031}{17.475 \pm 0.787}$	$\frac{.812 \pm .031}{20.625 \pm 0.787}$
B	$\frac{.1248 \begin{smallmatrix} +.0000 \\ -.0003 \end{smallmatrix}}{3.1699 \begin{smallmatrix} +0.0000 \\ -0.0076 \end{smallmatrix}}$ Dia.	$\frac{.2500 \begin{smallmatrix} +.0000 \\ -.0005 \end{smallmatrix}}{6.3500 \begin{smallmatrix} +0.0000 \\ -0.0127 \end{smallmatrix}}$ Dia.
C	$\frac{.281 \begin{smallmatrix} +.000 \\ -.002 \end{smallmatrix}}{7.137 \begin{smallmatrix} +0.000 \\ -.051 \end{smallmatrix}}$ Dia.	$\frac{.406 \begin{smallmatrix} +.000 \\ -.002 \end{smallmatrix}}{10.312 \begin{smallmatrix} +0.000 \\ -.051 \end{smallmatrix}}$ Dia.
D	1/4-32 UNEF Thread	3/8-32 UNEF Thread

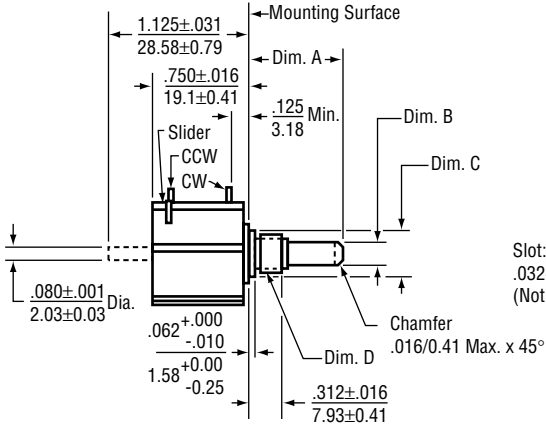

Slot: $.032 \pm .005 / 0.813 \pm 0.127$ Wide X
 $.032 \pm .010 - .000 / 0.813 \pm 0.254 - 0.000$ Deep
(Not on Rear Shaft Models)

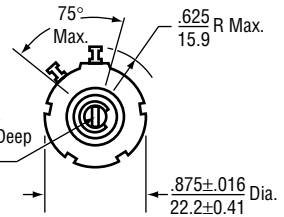

OPTIONAL TERMINAL CONFIGURATION

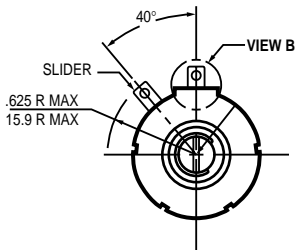

Use Special Feature Code "FT" to order.

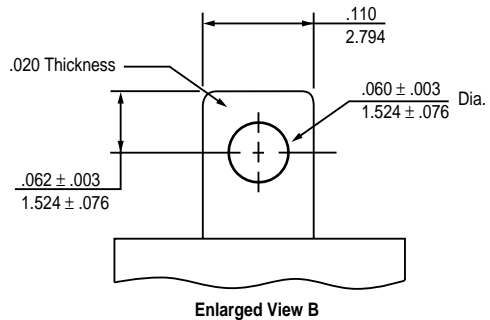

Enlarged View B

OUTLINE DIMENSIONS (Inch/mm)

Model 8143
Servo Mount with Ball Bearing

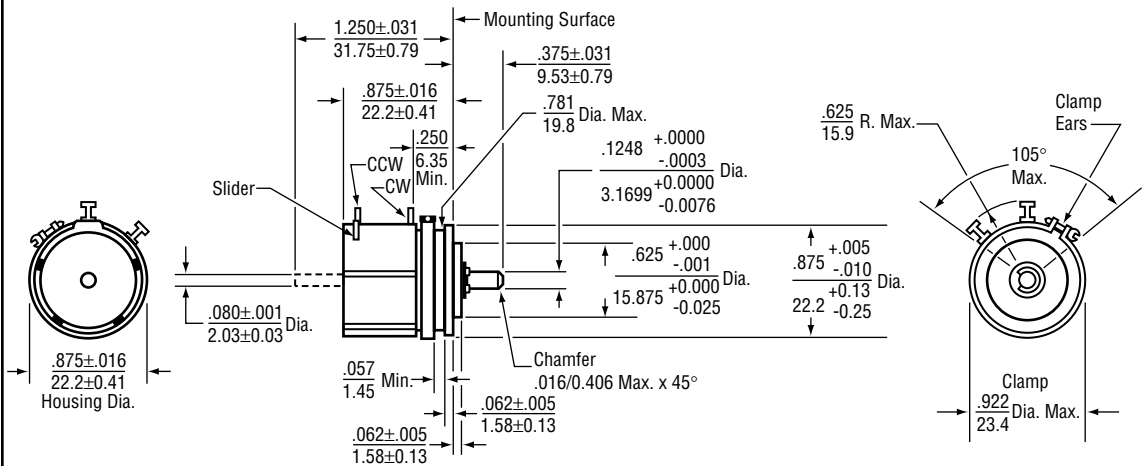

OPTIONAL TERMINAL CONFIGURATION

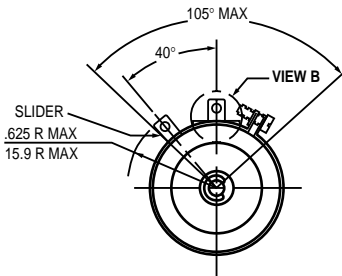

Use Special Feature Code "FT" to order.

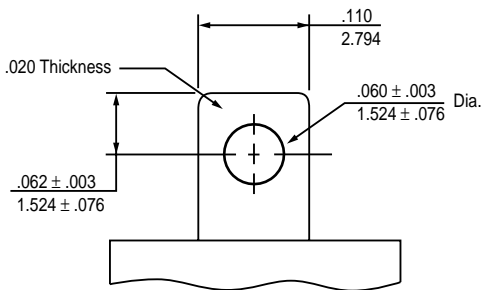

Enlarged View B

SPECIAL FEATURES

Center Tap	CT
Linearity Tape	LT
Rear Shaft Extension (8143, 8146 single cup only)	RS
Flatted Shaft	FS
Slotted Shaft (Standard on single gang 8146 without RS)	SS
Shaft Lock (8141, 8146 only)	SL
High Torque 2–6 oz.-in. (8146 only)	HT
Additional Gangs	2G
Gold plated solder lug terminals (See optional terminal configuration)	FT

2

ORDERING INFORMATION

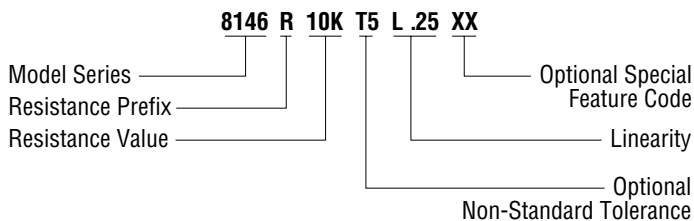

MATCHING TURNS COUNTING DIALS

8141: RBJ, 2601, 2641

8146: 2606, 2607, 2626, 2627, 2646, 2647, 2126, 2606S, 2607S, 2646S, 2647S, RB

CIRCUIT DIAGRAM

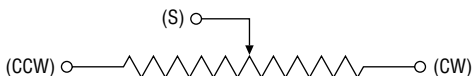

NOTES

Metric equivalents, based on 1 inch = 25.4mm are rounded to the same number of significant figures as in the original English units and are provided for general information only.

Tolerances unless otherwise specified:
 Linear = ± .01 inches
 (.25mm)
 Angular = ± 2 degrees

