

# XC9215/9216/9217 Series

500mA Synchronous Step-Down DC/DC Converters



May 13, 2004 V4

\* GO (Green Operation) Compatible

- Synchronous Step-down DC/DC
- High Efficiency 92%
- Low Ripple Rejection 10mV
- Output Current 500mA  
(VIN=3.0V, VOUT=1.8V)\*
- Oscillation Frequency 600kHz, 1.2MHz
- PWM fixed control (XC9215 series)
- PWM/PFM automatic switching control (XC9216 series)
- Manual selection of switching control (XC9217 series)
- Maximum Duty Ratio 100%
- Ceramic Capacitor Compatible
- Ultra Small Packages SOT-25, USP-6B

## ■ GENERAL DESCRIPTION

The XC9215/9216/9217 series is a group of synchronous-rectification type DC/DC converters with a built-in 0.6Ω P-channel driver transistor and 0.7Ω N-channel switching transistor, designed to allow the use of ceramic capacitors. The ICs enable a high efficiency, stable power supply with an output current of 500mA to be configured using only a coil and two capacitors connected externally.

Minimum operating voltage is 2.0V. Output voltage is internally programmable in a range from 0.9V to 4.0V in increments of 0.1V (accuracy: ± 2.0%).

With the built-in oscillator, oscillation frequency is selectable from 600kHz and 1.2MHz to make available the frequency best suited to your particular application.

As for operation mode, the XC9215 series is PWM control, the XC9216 series is automatic PWM/PFM switching control and the XC9217 series can be manually switched between the PWM control mode and the automatic PWM/PFM switching control mode, allowing fast response, low ripple and high efficiency over the full range of load (from light load to high output current conditions).

The soft start and current control functions are internally optimized. During standby, all circuits are shutdown to reduce current consumption to as low as 1.0μA or less. With the built-in U.V.L.O. (Under Voltage Lock Out) function, the internal P channel driver transistor is forced OFF when input voltage becomes 1.4V or lower. Two types of package, 250mW (SOT-25) and 100 mW (USP-6B), are available.

## ■ TYPICAL APPLICATION CIRCUIT

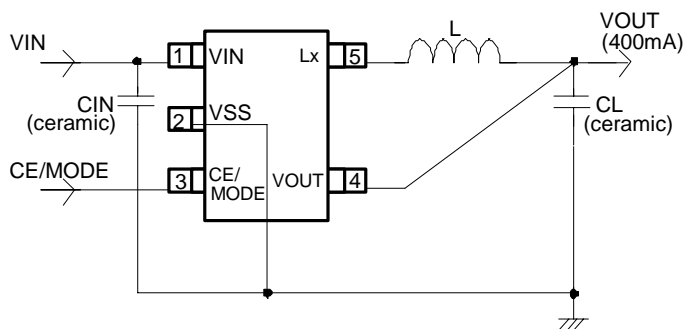

## ■ APPLICATIONS

- Mobile phones (PDC, GSM, CDMA, IMT200 etc.)
- Bluetooth equipment
- PDAs
- Portable communication modem
- Portable games
- Cameras
- Digital cameras
- Cordless phones
- Notebook computers

## ■ FEATURES

- P-ch Driver Tr. Built-in ON resistance 0.6Ω
- N-ch ON resistance 0.7Ω
- Synchronous Driver Tr. Built-in ON resistance 0.7Ω
- Input Voltage Range 2.0 ~ 6.0V
- Output Voltage Range 0.9V~4.0V (100mV increments)
- High Efficiency 92% (TYP.)  
(VIN=3.0V, VOUT=1.8V, IOU=100mA)\*
- Output current 500mA  
(VIN=3.0V, VOUT=1.8V)\*
- Oscillation Frequency 600kHz, 1.2MHz  
(Fixed frequency accuracy ±15%)
- Ultra Small Packages SOT-25 (SOT-23-5)  
USP-6B
- Soft-start circuit built-in
- Current limiter circuit built-in (constant current & latching)
- Low ESR ceramic capacitor compatible

\* Performance depends on external components and wiring on the PCB.

## ■ TYPICAL PERFORMANCE CHARACTERISTICS

○ Efficiency vs. Output Current

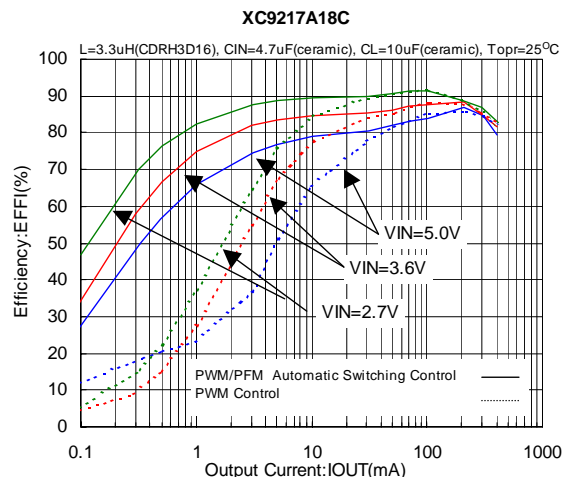

# XC9215/9216/9217 Series

500mA Synchronous Step-Down DC/DC Converters



## PIN CONFIGURATION

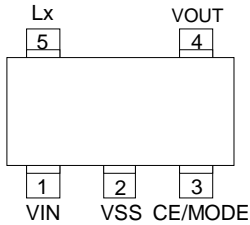

SOT-25 (TOP VIEW)

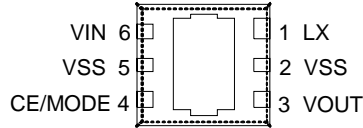

USP-6B (BOTTOM VIEW)

\* Please short the VSS pin (pin no. 2 and 5) before use. Connection of the heat dissipation pad to any pin on the circuit is not recommended. If the pad must be connected due to a problem of heat dissipation or mounting intensity, connect to the VSS pin (pin no. 5).

## PIN ASSIGNMENT

PIN NUMBER		PIN NAME	FUNCTION
SOT-25	USP-6B		
1	6	VIN	Power Input
2	2, 5	VSS	Ground
3	4	CE / MODE	Chip Enable Mode Switch
4	3	VOUT	Output Voltage Sense
5	1	Lx	Switching Output

## PRODUCT CLASSIFICATION

○ Ordering Information

- XC9215**①②③④⑤⑥ PWM fixed control
- XC9216**①②③④⑤⑥ PWM / PFM automatic switching control
- XC9217**①②③④⑤⑥ PWM fixed control ↔ PWM / PFM automatic switching, manual switching

DESIGNATOR	SYMBOL	DESCRIPTION
①	A	Transistor built-in, Output voltage internally set (VOUT product), Soft start Internally set, Current limit 700mA CE input logic High Active, CE pin open (Standard)
	B	CE input logic Low Active, CE pin open (Semi-custom)
	C	CE input logic High Active, Pull-down resistor built-in (Semi-custom)
	D	CE input logic Low Active, Pull-up resistor built-in (Semi-custom)
②③	Integer	Output voltage: e.g. 1.5V Output ⇔ ② = 1, ③ = 5
④	M	Package Types: SOT-25 (SOT-23-5)
⑤	D	USP-6B
⑥	R	Device Orientation: Embossed Tape : Standard Feed
	L	Embossed Tape : Reverse Feed



# XC9215/9216/9217 Series

500mA Synchronous Step-Down DC/DC Converters



## MARKING RULE

○ SOT-25 (SOT-23-5)

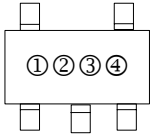

SOT-25 (TOP VIEW)

Mark ① Represents product series and the type of DC/DC converter

SYMBOL	PRODUCT SERIES
<b>E</b>	XC9215A x x x M x
<b>F</b>	XC9216A x x x M x
<b>G</b>	XC9217A x x x M x

\* Character inversion used.

Mark ② Represents the integer of output voltage and oscillation frequency

OUTPUT VOLTAGE	SYMBOL	
	FOSC=600kHz	FOSC=1.2MHz
	(XC92 x x A ② x 6 M x)	(XC92 x x A ② x C M x)
0.X	0	0
1.X	1	1
2.X	2	2
3.X	3	3
4.X	4	4

Mark ③ Represents the decimal point of output voltage and oscillation frequency

OUTPUT VOLTAGE	SYMBOL	
	FOSC=600kHz	FOSC=1.2MHz
	(XC92 x x A ③ x 6 M x)	(XC92 x x A ③ x C M x)
X.0	0	A
X.1	1	B
X.2	2	C
X.3	3	D
X.4	4	E
X.5	5	F
X.6	6	H
X.7	7	K
X.8	8	L
X.9	9	M

\* Output voltage 0.9V ~ 4.0V (100mV increments) are standard products.

Please ask our sales contact for output voltages of 50mV increments (semi-custom products).

Mark ④ Represents production lot number

0 to 9, A to Z, reversed character of 0 to 9 and A to Z repeated (G, I, J, O, Q excepted)

# XC9215/9216/9217 Series

500mA Synchronous Step-Down DC/DC Converters



## MARKING RULE (Continued)

○ USP-6B

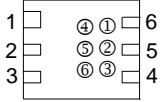

USP-6B (TOP VIEW)

Mark ① Represents product series and the type of DC/DC converter

SYMBOL	PRODUCT SERIES
<b>F</b>	XC9215A x x x D x
<b>B</b>	XC9216A x x x D x
<b>E</b>	XC9217A x x x D x

\* Character inversion used.

Mark ② Represents the type of voltage regulators

SYMBOL	PRODUCT SERIES	CURRENT LIMIT
A	XC92 x x A x x x D x	700mA

Mark ③ Represents the integer of output voltage

OUTPUT VOLTAGE	SYMBOL
	(XC92 x x A ③ x x D x)
0.X	0
1.X	1
2.X	2
3.X	3
4.X	4

Mark ④ Represents the decimal point of output voltage

OUTPUT VOLTAGE	SYMBOL
	(XC92 x x A ④ x x D x)
X.0	0
X.1	1
X.2	2
X.3	3
X.4	4
X.5	5
X.6	6
X.7	7
X.8	8
X.9	9

\* Output voltage 0.9V ~ 4.0V (100mV increments) are standard products.

Please ask our sales contact for output voltages of 50mV increments (semi-custom products).

Mark ⑤ Represents oscillation frequency

SYMBOL	PRODUCT SERIES	FREQUENCY
6	XC92 x x A x x 6 D x	600kHz
C	XC92 x x A x x C D x	1.2MHz

Mark ⑥ Represents production lot number

0 to 9, A to Z, reversed character of 0 to 9 and A to Z repeated (G, I, J, O, Q excepted)

# XC9215/9216/9217 Series

500mA Synchronous Step-Down DC/DC Converters



## ■ BLOCK DIAGRAM

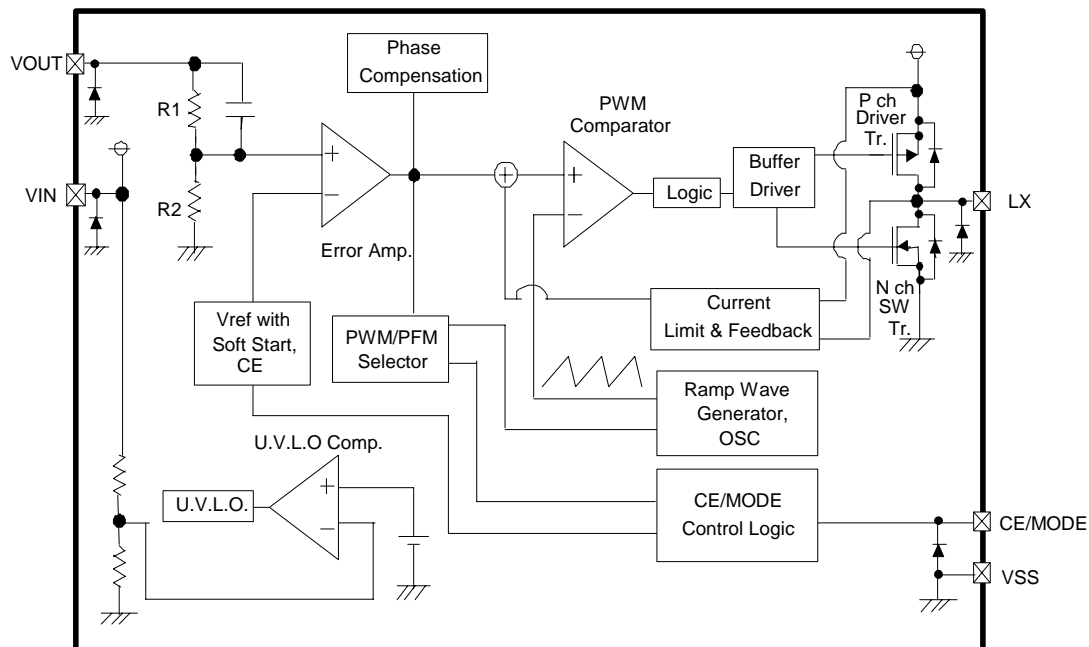

**Note:**

The signal from CE/MODE Control Logic to PWM/PFM Selector is being fixed to "L" level inside, and XC9215 series chooses only PWM control. The signal from CE/MODE Control Logic to PWM/PFM Selector is being fixed to "H" level inside, and XC9216 series chooses only PWM/PFM automatic switching control.

## ■ ABSOLUTE MAXIMUM RATINGS

Ta=25°C

PARAMETER	SYMBOL	RATINGS	UNITS
VIN Pin Voltage	VIN	- 0.3 ~ 6.5	V
Lx Pin Voltage	VLx	- 0.3 ~ VIN + 0.3	V
VOUT Pin Voltage	VOUT	- 0.3 ~ 6.5	V
CE / MODE Pin Voltage	VCE	- 0.3 ~ VIN + 0.3	V
Lx Pin Current	ILx	± 1000	mA
Power Dissipation	SOT-25	250	mW
	USP-6B	100	
Operating Temperature Range	Topr	- 40 ~ + 85	°C
Storage Temperature Range	Tstg	- 55 ~ +125	°C

# XC9215/9216/9217 Series

500mA Synchronous Step-Down DC/DC Converters



## ELECTRICAL CHARACTERISTICS

XC9215A18Cxx, XC9216A18Cxx, XC9217A18Cxx

VOUT=1.8V, FOSC=1.2MHz, Ta=25°C

PARAMETER	SYMBOL	CONDITIONS	MIN	TYP	MAX	UNIT	CIRCUIT
Output Voltage	VOUT	When connected to external components, CE=VIN, IOU=30mA	1.764	1.800	1.836	V	①
Operating Voltage Range	VIN		2.0	-	6.0	V	①
Maximum Output Current	IOU <sub>MAX</sub>	VIN=3.0V, When connected to external components (*10)	500	-	-	mA	①
U.V.L.O Voltage	VUVLO	CE=VIN, VOUT=0V, Voltage which Lx pin voltage holding "L" level (*1)	1.0	1.4	1.78	V	②
Supply Current	IDD	VIN=CE=3.6V, VOUT=fixed voltage x 1.1V	-	70	115	μA	③
Stand-by Current	I <sub>stb</sub>	VIN=3.6V, CE=0V, VOUT=fixed voltage x 1.1V	-	0	1.0	μA	③
Oscillation Frequency	FOSC	When connected to external components, IOU=100mA	1020	1200	1380	kHz	①
PFM Switch Current	IPFM	When connected to external components, CE=VIN, IOU=1mA	100	140	180	mA	①
Maximum Duty Ratio	MAXDTY	CE=VIN, VOUT=0V	100	-	-	%	④
Minimum Duty Ratio	MINDTY	CE=VOUT=VIN	-	-	0	%	④
Efficiency (*2)	EFFI	When connected to external components, CE=VIN=3.0V, IOU=100mA	-	90	-	%	①
Lx SW "H" ON Resistance	RLxH	CE=0.5VIN, VOUT=0V, ILx=100mA (*3)	-	0.6	1.2	Ω	⑤
Lx SW "L" ON Resistance	RLxL	CE=0.5VIN, ILx=100mA (*4)	-	0.7	1.4	Ω	-
Lx SW "H" Leak Current	ILeakH	VIN=VOUT=5.0V, CE=0V, Lx=0V (*5)	-	0.01	1.0	μA	⑥
Lx SW "L" Leak Current	ILeakL	VIN=VOUT=5.0V, CE=0V, Lx=5.0V	-	0.01	1.0	μA	⑥
Current Limit	ILIM	VIN=CE=5.0V, VOUT=0V	600	700	-	mA	⑦
Output Voltage Temperature Characteristics	$\frac{\Delta VOUT}{VOUT \cdot \Delta T_{opr}}$	IOU=30mA -40°C ≤ Topr ≤ 85°C	-	+100	-	ppm/°C	①
CE "H" Voltage	VCEH	VOUT=0V, When CE voltage is applied Lx determine "H"	0.9	-	VIN	V	⑧
CE "L" Voltage	VCEL	VOUT=0V, When CE voltage is applied Lx determine "L"	VSS	-	0.3	V	⑧
PWM "H" Level Voltage	VPWMH	When connected to external components, IOU=1mA (*6)	-	-	VIN - 1.0	V	①
PWM "L" Level Voltage	VPWML	When connected to external components, IOU=1mA (*6)	VIN - 0.3	-	-	V	①
CE "H" Current	ICEH	VIN=CE=5.5V, VOUT=0V	- 0.1	-	0.1	μA	⑧
CE "L" Current	ICEL	VIN=5.5V, CE=0V, VOUT=0V	- 0.1	-	0.1	μA	⑧
Soft-Start Time	TSS	When connected to external components, CE=0V ⇒ VIN, IOU=1mA	0.5	1.0	3.0	msec	①
Latch Time	Tlat	When connected to external components, VIN=CE=5.0V, Short VOUT by 1Ω resistance (*7)	1	-	20	msec	⑨

Test conditions: Unless otherwise stated, VIN=3.6V

(\*1) Including hysteresis operating voltage range.

(\*2)  $EFFI = \{ ( \text{Output Voltage} \times \text{Output Current} ) / ( \text{Input Voltage} \times \text{Input Current} ) \} \times 100$

(\*3) On resistance (Ω)= Lx pin measurement voltage / 100mA

(\*4) R&D value

(\*5) When temperature is high, a current of approximately 20μA (maximum) may leak.

(\*6) The CE/MODE pin of the XC9217A series works also as an external PWM control and PWM/PFM control switching pin. When the IC is in the operation, control is switched to the PWM mode when the CE/MODE pin voltage is equal to or greater than VIN minus 0.3V, and to the automatic PWM/PFM switching mode when the CE/MODE pin voltage is equal to or lower than VIN minus 1.0V and equal to or greater than VCEH.

(\*7) Time until it short-circuits DCOUT with GND through 1Ω of resistance from a state of operation and is set to DCOUT=0V from current limit pulse generating.

(\*8) There is no PFM switch current for XC9215 series. The PFM switch current is only for XC9216/17 series.

(\*9) There is no PWM "H" Level Voltage or PWM "L" Level Voltage for XC9215/16 series. The characteristics are only for XC9217 series.

(\*10) When the difference between the input and the output is small, some cycles may be skipped completely before current maximizes.

If current is further pulled from this state, output voltage will decrease because of P-ch driver ON resistance.

# XC9215/9216/9217 Series

500mA Synchronous Step-Down DC/DC Converters



## ELECTRICAL CHARACTERISTICS

XC9215A33Cxx, XC9216A33Cxx, XC9217A33Cxx

VOUT=3.3V, FOSC=1.2MHz, Ta=25°C

PARAMETER	SYMBOL	CONDITIONS	MIN	TYP	MAX	UNIT	CIRCUIT
Output Voltage	VOUT	When connected to external components, CE=VIN, IOU=30mA	3.234	3.300	3.366	V	①
Operating Voltage Range	VIN		2.0	-	6.0	V	①
Maximum Output Current	IOU <sub>MAX</sub>	VIN=4.5V, When connected to external components (*10)	500	-	-	mA	①
U.V.L.O Voltage	VUVLO	CE=VIN, VOUT=0V, Voltage which Lx pin voltage holding "L" level (*1)	1.0	1.40	1.78	V	②
Supply Current	IDD	VIN=CE=5.0V, VOUT=fixed voltage x 1.1V	-	75	120	μA	③
Stand-by Current	I <sub>stb</sub>	VIN=5.0V, CE=0V, VOUT=fixed voltage x 1.1V	-	0	1.0	μA	③
Oscillation Frequency	FOSC	When connected to external components, IOU=100mA	1020	1200	1380	kHz	①
PFM Switch Current	IPFM	When connected to external components, CE=VIN, IOU=1mA	100	140	180	mA	①
Maximum Duty Ratio	MAXDTY	CE=VIN, VOUT=0V	100	-	-	%	④
Minimum Duty Ratio	MINDTY	CE=VOUT=VIN	-	-	0	%	④
Efficiency (*2)	EFFI	When connected to external components, CE=VIN=4.5V, IOU=100mA	-	92	-	%	①
Lx SW "H" ON Resistance	RLxH	CE=0.5VIN, VOUT=0V, ILx=100mA (*3)	-	0.5	1.0	Ω	⑤
Lx SW "L" ON Resistance	RLxL	CE=0.5VIN, ILx=100mA (*4)	-	0.6	1.2	Ω	-
Lx SW "H" Leak Current	ILeakH	VIN=VOUT=5.0V, CE=0V, Lx=0V (*5)	-	0.01	1.0	μA	⑥
Lx SW "L" Leak Current	ILeakL	VIN=VOUT=5.0V, CE=0V, Lx=5.0V	-	0.01	1.0	μA	⑥
Current Limit	ILIM	VIN=CE=5.0V, VOUT=0V	600	700	-	mA	⑦
Output Voltage Temperature Characteristics	$\frac{\Delta VOUT}{VOUT \cdot \Delta T_{opr}}$	IOU=30mA -40°C ≤ Topr ≤ 85°C	-	±100	-	ppm/°C	①
CE "H" Voltage	VCEH	VOUT=0V, When CE voltage is applied Lx determine "H"	0.9	-	VIN	V	⑧
CE "L" Voltage	VCEL	VOUT=0V, When CE voltage is applied Lx determine "L"	VSS	-	0.3	V	⑧
PWM "H" Level Voltage	VPWMH	When connected to external components, IOU=1mA (*6)	-	-	VIN - 1.0	V	①
PWM "L" Level Voltage	VPWML	When connected to external components, IOU=1mA (*6)	VIN - 0.3	-	-	V	①
CE "H" Current	ICEH	VIN=CE=5.5V, VOUT=0V	- 0.1	-	0.1	μA	⑧
CE "L" Current	ICEL	VIN=5.5V, CE=0V, VOUT=0V	- 0.1	-	0.1	μA	⑧
Soft-Start Time	TSS	When connected to external components, CE=0V ⇒ VIN, IOU=1mA	0.5	1.0	3.0	msec	①
Latch Time	Tlat	When connected to external components, VIN=CE=5.0V, Short VOUT by 1Ω resistance (*7)	1	-	20	msec	⑨

Test conditions: Unless otherwise stated, VIN=5.0V

(\*1) Including hysteresis operating voltage range.

(\*2)  $EFFI = \{ ( \text{Output Voltage} \times \text{Output Current} ) / ( \text{Input Voltage} \times \text{Input Current} ) \} \times 100$

(\*3) On resistance (Ω)= Lx pin measurement voltage / 100mA

(\*4) R&D value

(\*5) When temperature is high, a current of approximately 20μA (maximum) may leak.

(\*6) The CE/MODE pin of the XC9217A series works also as an external PWM control and PWM/PFM control switching pin. When the IC is in the operation, control is switched to the PWM mode when the CE/MODE pin voltage is equal to or greater than VIN minus 0.3V, and to the automatic PWM/PFM switching mode when the CE/MODE pin voltage is equal to or lower than VIN minus 1.0V and equal to or greater than VCEH.

(\*7) Time until it short-circuits DCOUT with GND through 1Ω of resistance from a state of operation and is set to DCOUT=0V from current limit pulse generating.

(\*8) There is no PFM switch current for XC9215 series. The PFM switch current is only for XC9216/17 series.

(\*9) There is no PWM "H" Level Voltage or PWM "L" Level Voltage for XC9215/16 series. The characteristics are only for XC9217 series.

(\*10) When the difference between the input and the output is small, some cycles may be skipped completely before current maximizes.

If current is further pulled from this state, output voltage will decrease because of P-ch driver ON resistance.



# XC9215/9216/9217 Series

500mA Synchronous Step-Down DC/DC Converters



## ■ TYPICAL APPLICATION CIRCUIT

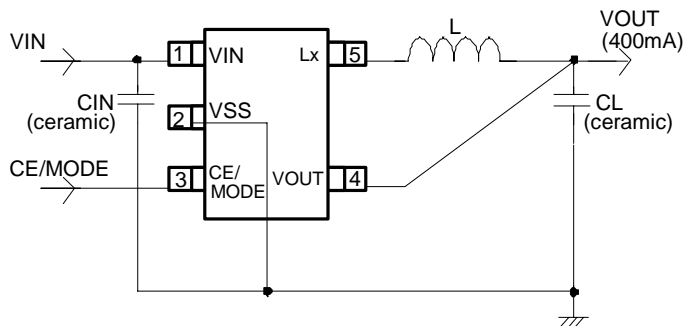

FOSC=1.2MHz  
L: 3.3μH (CDRH3D16 SUMIDA)  
CIN: 4.7μF (Ceramic)  
CL: 10μF (Ceramic)

FOSC=600kHz  
L: 6.8μH (CDRH4D18C SUMIDA)  
CIN: 4.7μF (Ceramic)  
CL: 10μF (Ceramic)

## ■ NOTES ON USE

### ○ Application Information

1. The XC9215/16/17 series is designed for use with ceramic output capacitors. If, however, the potential difference between dropout voltage or output current is too large, a ceramic capacitor may fail to absorb the resulting high switching energy and oscillation could occur on the output. If the input-output potential difference is large, connect an electrolytic capacitor in parallel to compensate for insufficient capacitance.
2. Spike noise and ripple voltage arise in a switching regulator as with a DC/DC converter. These are greatly influenced by external component selection, such as the coil inductance, capacitance values, and board layout of external components. Once the design has been completed, verification with actual components should be done.
3. Depending on the input-output voltage differential, or load current, some pulses may be skipped, and the ripple voltage may increase.
4. When the difference between VIN and VOUT is large in PWM control, very narrow pulses will be outputted, and there is the possibility that some cycles may be skipped completely.
5. When the difference between VIN and VOUT is small, and the load current is heavy, very wide pulses will be outputted and there is the possibility that some cycles may be skipped completely: in this case, the Lx pin may not go low at all.
6. With the IC, the peak current of the coil is controlled by the current limit circuit. Since the peak current increases when dropout voltage or load current is high, current limit starts operating, and this can lead to instability. When peak current becomes high, please adjust the coil inductance value and fully check the circuit operation. In addition, please calculate the peak current according to the following formula:  
$$I_{pk} = (VIN - VOUT) * OnDuty / (2 * L * FOSC) + IOUT$$

L: Coil Inductance Value  
FOSC: Oscillation Frequency
7. When the peak current, which exceeds limit current, flows within the specified time, the built-in Pch driver transistor is turned off. During the time until it detects limit current and before the built-in transistor can be turned off, the current for limit current flows; therefore, care must be taken when selecting the rating for the coil or the schottky diode.
8. When VIN is less than 2.4V, limit current may not be reached because voltage falls caused by ON resistance.
9. Care must be taken when laying out the PC Board, in order to prevent misoperation of the current limit mode. Depending on the state of the PC Board, latch time may become longer and latch operation may not work. In order to avoid the effect of noise, the board should be laid out so that capacitors are placed as close to the chip as possible.
10. Use of the IC at voltages below the recommended voltage range may lead to instability.
11. This IC should be used within the stated absolute maximum ratings in order to prevent damage to the device.
12. When the IC is used in high temperature, output voltage may increase up to input voltage level at no load because of the leak current of the driver transistor.

# XC9215/9216/9217 Series

500mA Synchronous Step-Down DC/DC Converters



## ■ NOTES ON USE (Continued)

### ○ Application Information (Continued)

13. When the inductance value of the coil is large and under the condition of large dropout voltage in continuous mode, operation may become unstable. A coil with an inductance value from 3.3 $\mu$ H to 6.8 $\mu$ H should be used. Please verify with actual parts.

ex.) VOUT = 0.9V  
FOOSC = 1.2MHz  
VIN = 6.0V  
IOUT = 70mA  
L : 10 $\mu$ H (CDRH4D18C)  
CIN : 4.7 $\mu$ F (Ceramic)  
CL : 10 $\mu$ F (Ceramic)

CH1: Lx 2V / div

CH2: VOUT 20mV / div

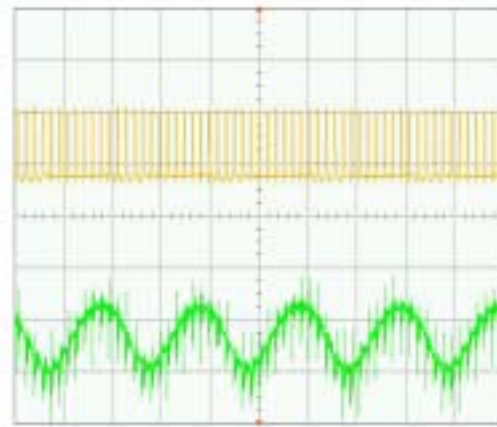

5 $\mu$ sec/div

14. The ripple voltage may increase when PFM/PWM automatic switching control changes to PFM control in continuous mode. Please adjust the inductance value and verify with actual parts.

ex.) VOUT = 1.8V  
FOOSC = 1.2MHz  
VIN = 2.39V  
IOUT = 70mA  
L : 3.3 $\mu$ H (CDRH3D16)  
CIN : 4.7 $\mu$ F (Ceramic)  
CL : 10 $\mu$ F (Ceramic)

CH1:Lx 2V / div

CH2: VOUT 20mV / div

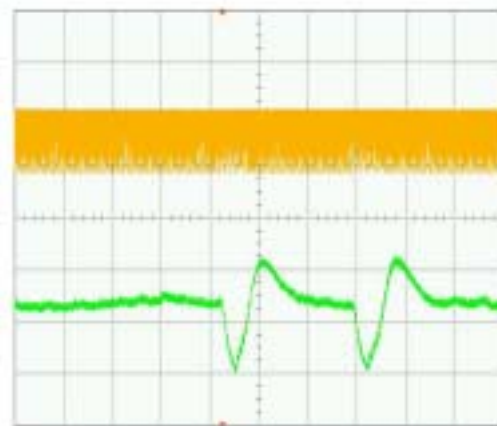

100 $\mu$ sec / div

# XC9215/9216/9217 Series

500mA Synchronous Step-Down DC/DC Converters



## ■ NOTES ON USE (Continued)

### ○ Application Information (Continued)

#### ● Instructions on Pattern Layout

1. In order to stabilize VIN's voltage level, we recommend that a by-pass capacitor (CIN) be connected as close as possible to the VIN & VSS pins.
2. Please mount each external component as close to the IC as possible.
3. Wire external components as close to the IC as possible and use thick, short connecting traces to reduce the circuit impedance.
4. Make sure that the PCB GND traces are as thick as possible, as variations in ground potential caused by high ground currents at the time of switching may result in instability of the IC.

#### ● Recommended Pattern Layout

##### SOT-25

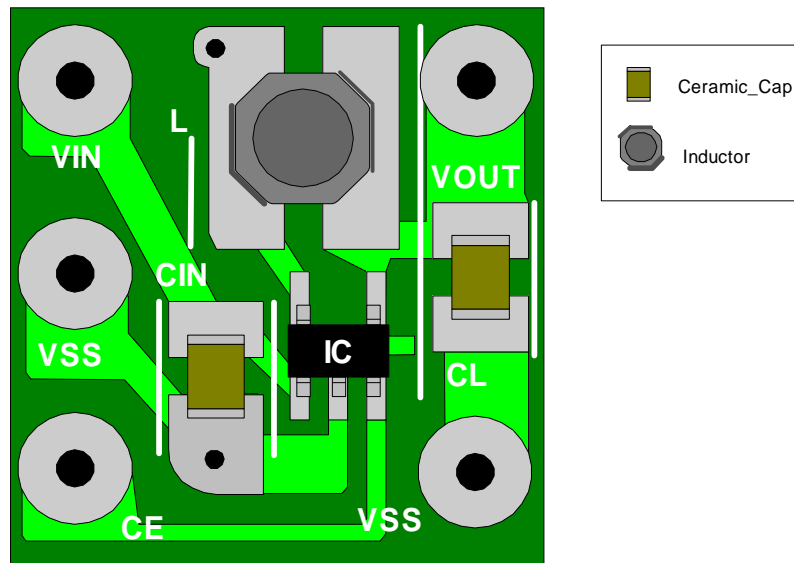

\* Please use an electric wire for VIN, VOUT, VSS, and CE.

##### USP-6B

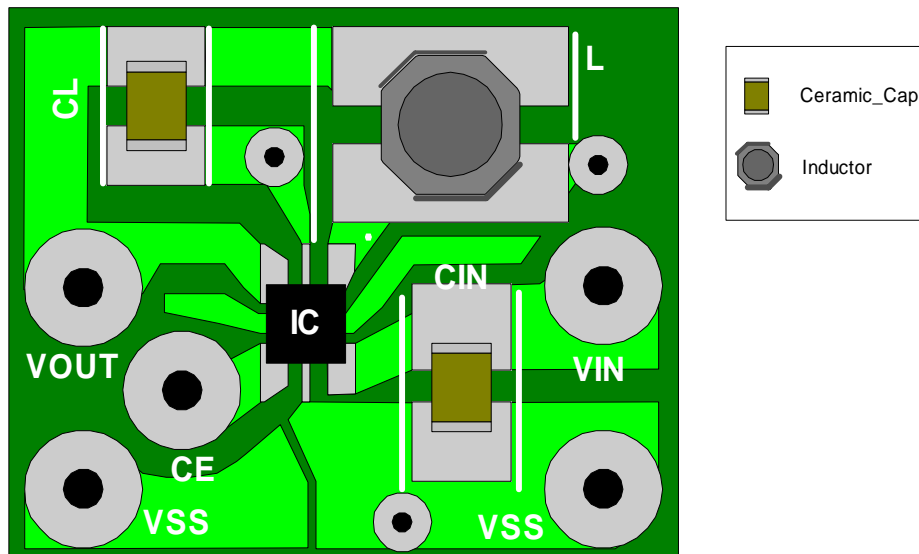

\* Please use an electric wire for VIN, VOUT, VSS, and CE.

# XC9215/9216/9217 Series

500mA Synchronous Step-Down DC/DC Converters



## ■ OPERATIONAL EXPLANATION

The XC9215/9216/9217 series consists of a reference voltage source, ramp wave circuit, error amplifier, PWM comparator, phase compensation circuit, output voltage adjustment resistors, P-channel MOSFET driver transistor, N-channel MOSFET switching transistor for the synchronous switch, current limiter circuit, U.V.L.O. circuit and others. The series ICs compare, using the error amplifier, the voltage of the internal voltage reference source with the feedback voltage from the VOUT pin through split resistors, R1 and R2. Phase compensation is performed on the resulting error amplifier output, to input a signal to the PWM comparator to determine the turn-on time during PWM operation. The PWM comparator compares, in terms of voltage level, the signal from the error amplifier with the ramp wave from the ramp wave circuit, and delivers the resulting output to the buffer driver circuit to cause the Lx pin to output a switching duty cycle. This process is continuously performed to ensure stable output voltage. The current feedback circuit monitors the P-channel MOS driver transistor current for each switching operation, and modulates the error amplifier output signal to provide multiple feedback signals. This enables a stable feedback loop even when a low ESR capacitor, such as a ceramic capacitor, is used, ensuring stable output voltage.

### <Reference Voltage Source>

The reference voltage source provides the reference voltage to ensure stable output voltage of the DC/DC converter.

### <Ramp Wave Circuit>

The ramp wave circuit determines switching frequency. The frequency is fixed internally and can be selected from 600kHz and 1.2MHz. Clock pulses generated in this circuit are used to produce ramp waveforms needed for PWM operation, and to synchronize all the internal circuits.

### <Error Amplifier>

The error amplifier is designed to monitor output voltage. The amplifier compares the reference voltage with the feedback voltage divided by the internal split resistors, R1 and R2. When a voltage lower than the reference voltage is fed back, the output voltage of the error amplifier increases. The gain and frequency characteristics of the error amplifier output are fixed internally to deliver an optimized signal to the mixer.

### <Current Limit>

The current limiter circuit of the XC9215 / 9216 / 9217 series monitors the current flowing through the P-channel MOS driver transistor connected to the Lx pin, and features a combination of the constant-current type current limit mode and the operation suspension mode.

- ① When the driver current is greater than a specific level, the constant-current type current limit function operates to turn off the pulses from the Lx pin at any given timing.
- ② When the driver transistor is turned off, the limiter circuit is then released from the current limit detection state.
- ③ At the next pulse, the driver transistor is turned on. However, the transistor is immediately turned off in the case of an over current state.
- ④ When the over current state is eliminated, the IC resumes its normal operation.

The IC waits for the over current state to end by repeating the steps ① through ③. If an over current state continues for a few msec and the above three steps are repeatedly performed, the IC performs the function of latching the OFF state of the driver transistor, and goes into operation suspension mode. Once the IC is in suspension mode, operations can be resumed by either turning the IC off via the CE/MODE pin, or by restoring power to the VIN pin. The suspension mode does not mean a complete shutdown, but a state in which pulse output is suspended; therefore, the internal circuitry remains in operation. The constant-current type current limit of the XC9215 / 9216 / 9217 series can be set at 700mA.

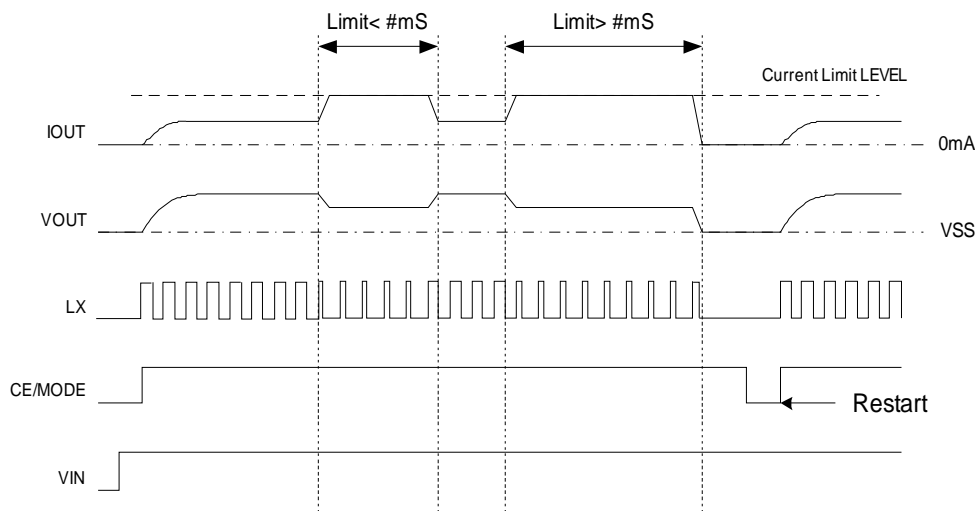

### <U.V.L.O. Circuit>

When the VIN pin voltage becomes 1.4V or lower, the P-channel output driver transistor is forced OFF to prevent false pulse output caused by unstable operation of the internal circuitry. When the VIN pin voltage becomes 1.8V or higher, switching operation takes place. By releasing the U.V.L.O. function, the IC performs the soft start function to initiate output startup operation. The soft start function operates even when the VIN pin voltage falls momentarily below the U.V.L.O. operating voltage. The U.V.L.O. circuit does not cause a complete shutdown of the IC, but causes pulse output to be suspended; therefore, the internal circuitry remains in operation.

# XC9215/9216/9217 Series

500mA Synchronous Step-Down DC/DC Converters



## OPERATIONAL EXPLANATION (Continued)

<CE/MODE Pin Function>

The operation of the XC9215A / 9216A / 9217A series will enter into the shut down mode when a low level signal is input to the CE/MODE pin. During the shut down mode, the current consumption occurs only in the detector and is 0μA (TYP.), with a state of high impedance at the Lx pin and VOUT pin. The IC starts its operation by inputting a high level signal to the CE/MODE pin. The input to the CE/MODE pin is a CMOS input and the sink current is 0μA (TYP.).

### XC9215A / 9216A series - Examples of how to use CE/MODE pin

(A)

SW_CE	STATUS
ON	Stand-by
OFF	Operation

(B)

SW_CE	STATUS
ON	Operation
OFF	Stand-by

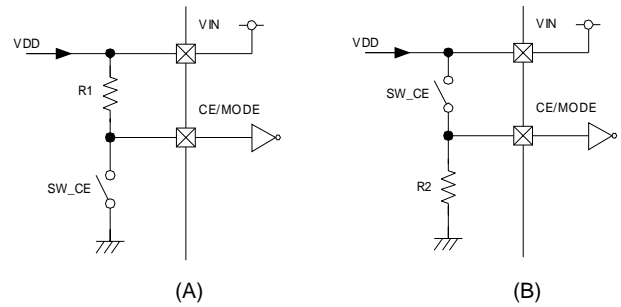

### XC9217A series - Examples of how to use CE/MODE pin

(A)

SW_CE	SW_PWM/PFM	STATUS
ON	*	PWM/PFM Automatic Switching Control
OFF	ON	PWM Control
OFF	OFF	Stand-by

(B)

SW_CE	SW_PWM/PFM	STATUS
ON	*	Stand-by
OFF	ON	PWM Control
OFF	OFF	PWM/PFM Automatic Switching Control

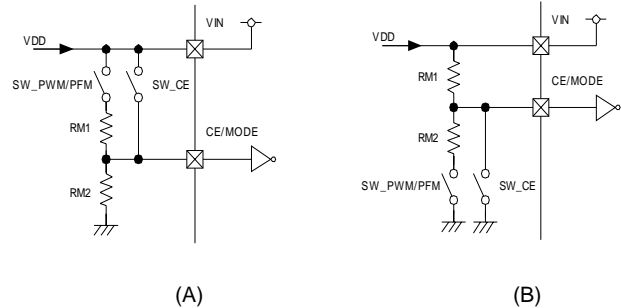

Intermediate voltage can be generated by RM1 and RM2. Please set the value of each R1, R2, RM1, RM2 at around 100kΩ. For switches, CPU open-drain I/O port and transistor can be used.

## FUNCTIONS

CE/MODE VOLTAGE LEVEL	OPERATION		
	XC9215A SERIES	XC9216A SERIES	XC9217A SERIES
H Level *1	Synchronous PWM Fixed Control	Synchronous PWM/PFM Automatic Switching Control	Synchronous PWM/PFM Automatic Switching Control
M Level *2			Synchronous PWM Fixed Control
L Level *3	Stand-by	Stand-by	Stand-by

\* CE/MODE pin voltage level range

- H level:  $V_{IN} - 0.3V \leq H \text{ Level} \leq V_{IN}$
- M level:  $0.9V \leq M \text{ Level} \leq V_{IN} - 1.0V$
- L level:  $0V \leq L \text{ Level} \leq 0.3V$

# XC9215/9216/9217 Series

500mA Synchronous Step-Down DC/DC Converters



## TEST CIRCUITS

Circuit ①

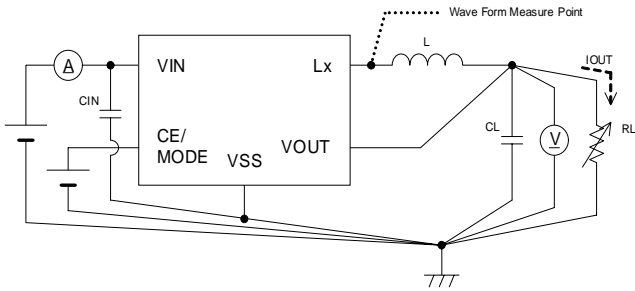

Circuit ②

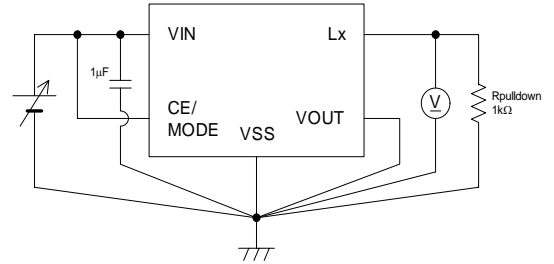

	600kHz	1.2MHz
CIN	4.7µF (Ceramic)	4.7µF (Ceramic)
CL	10µF (Ceramic)	10µF (Ceramic)
L	6.8µH (CDRH4D18C SUMIDA)	3.3µH (CDRH3D16 SUMIDA)

Circuit ③

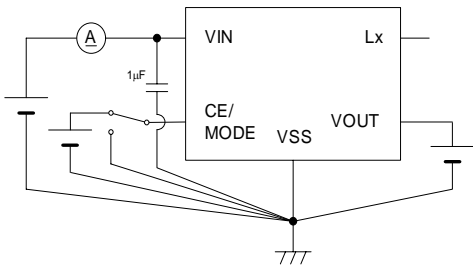

Circuit ④

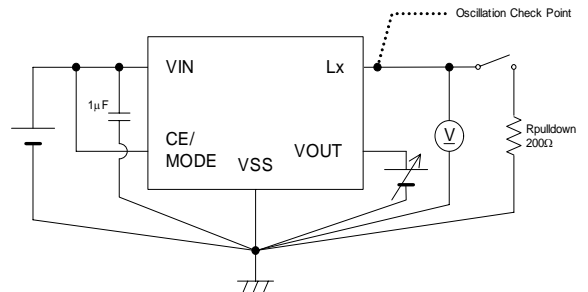

Circuit ⑤

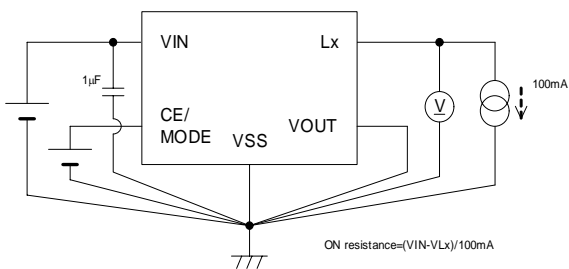

Circuit ⑥

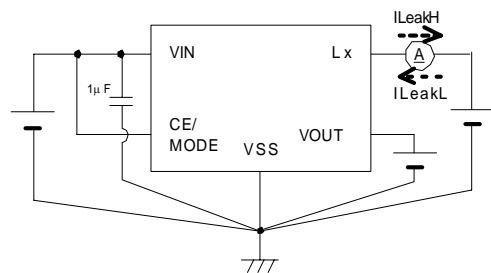

# XC9215/9216/9217 Series

500mA Synchronous Step-Down DC/DC Converters



## TEST CIRCUITS (Continued)

Circuit ⑦

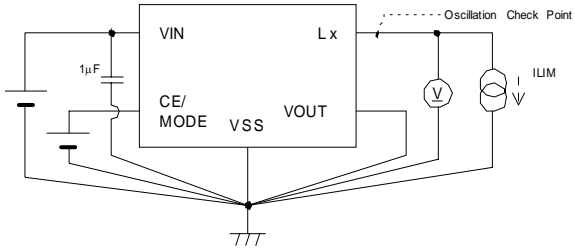

Circuit ⑧

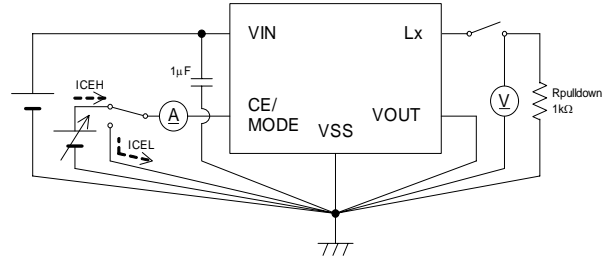

Circuit ⑨

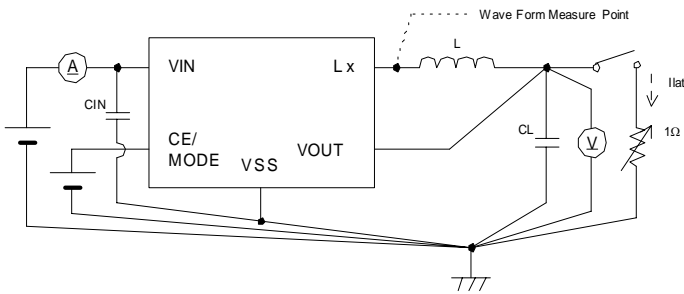

	600kHz	1.2MHz
CIN	4.7µF (Ceramic)	4.7µF (Ceramic)
CL	10µF (Ceramic)	10µF (Ceramic)
L	6.8µH (CDRH4D18C SUMIDA)	3.3µH (CDRH3D16 SUMIDA)

# XC9215/9216/9217 Series

500mA Synchronous Step-Down DC/DC Converters



## ■ TYPICAL PERFORMANCE CHARACTERISTICS

### (1) Efficiency vs. Output Current

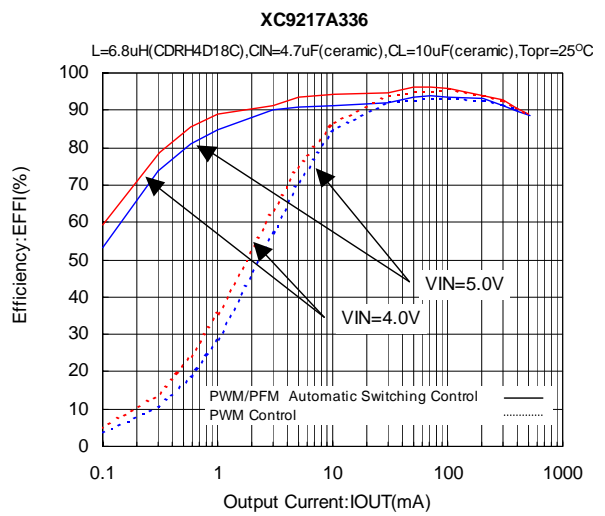
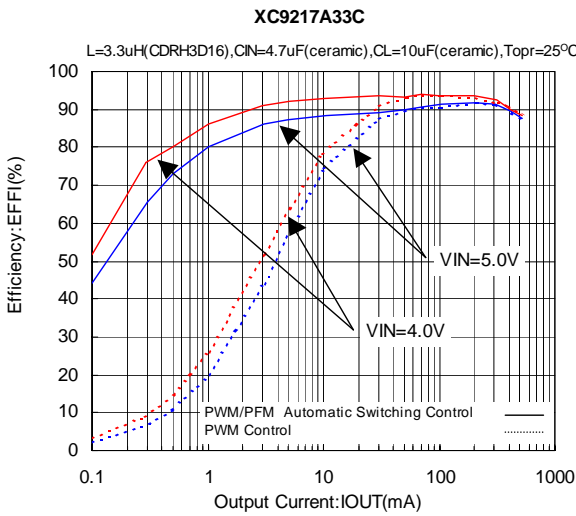
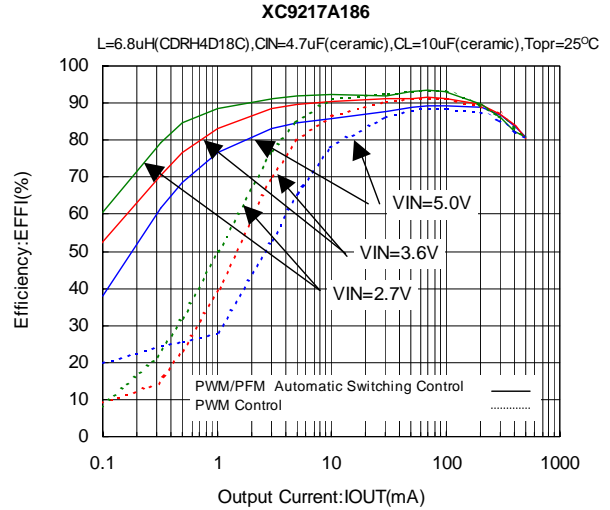
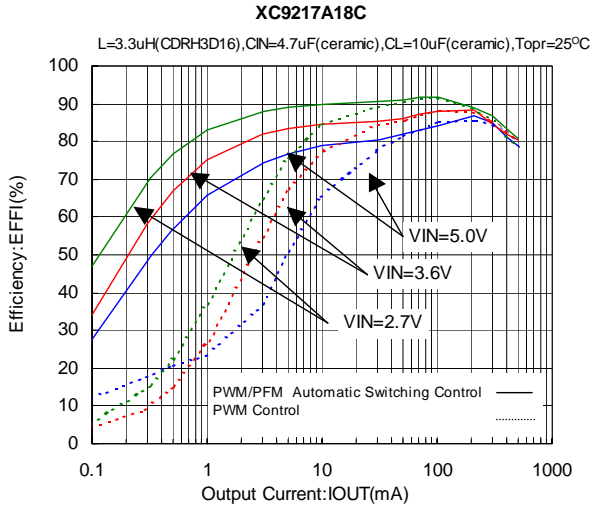

### (2) Output Voltage vs. Output Current

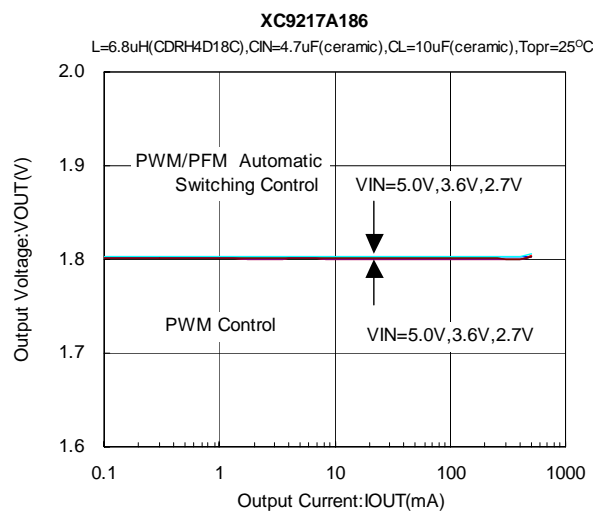
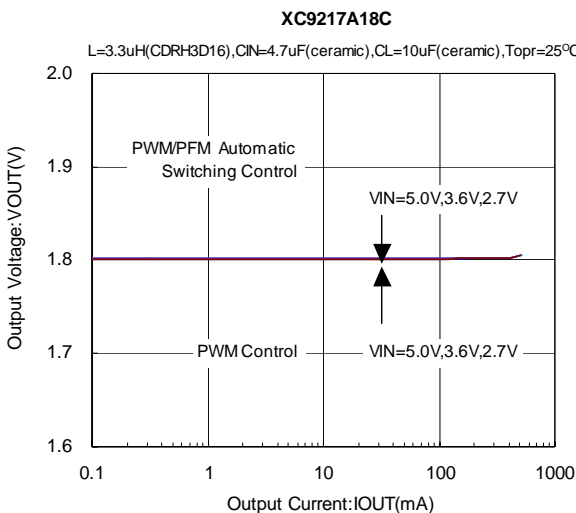



# XC9215/9216/9217 Series

500mA Synchronous Step-Down DC/DC Converters



## TYPICAL PERFORMANCE CHARACTERISTICS (Continued)

### (3) Ripple Voltage vs. Output Current

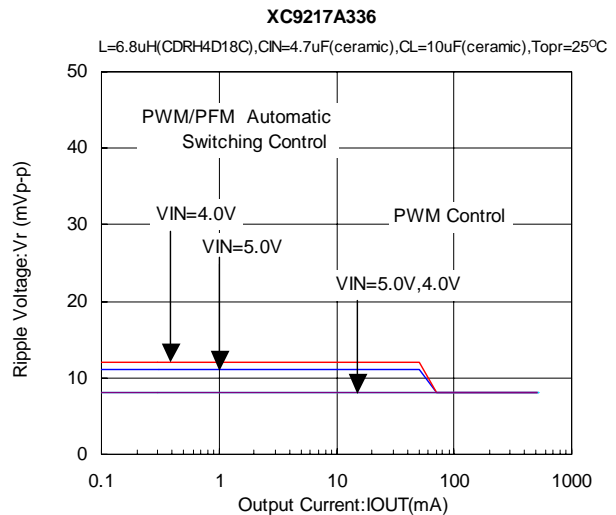
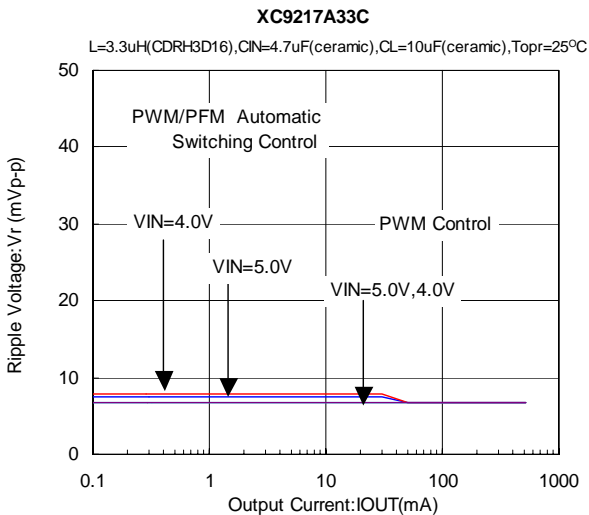
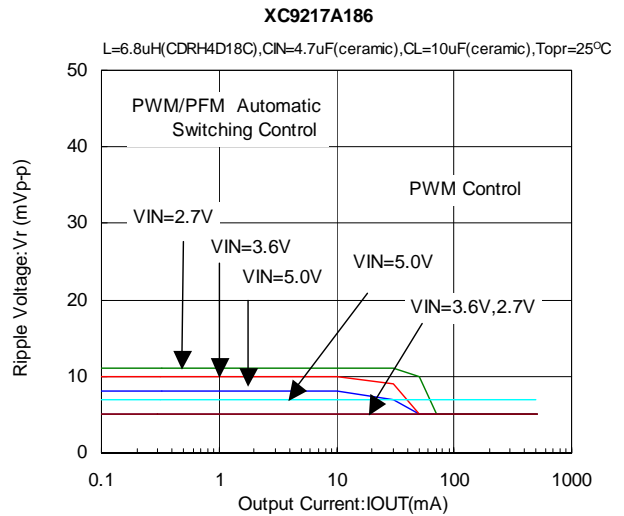
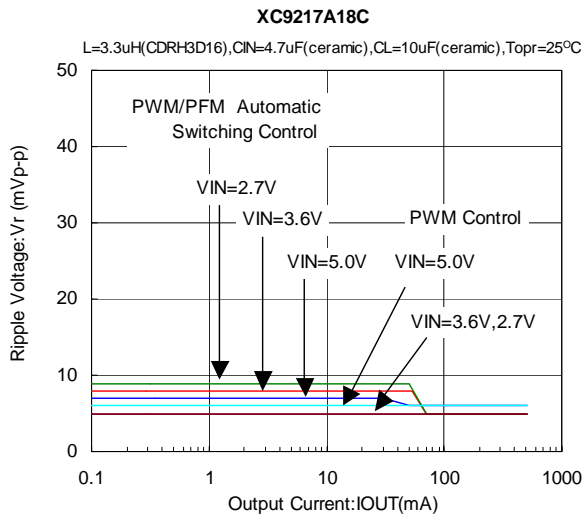
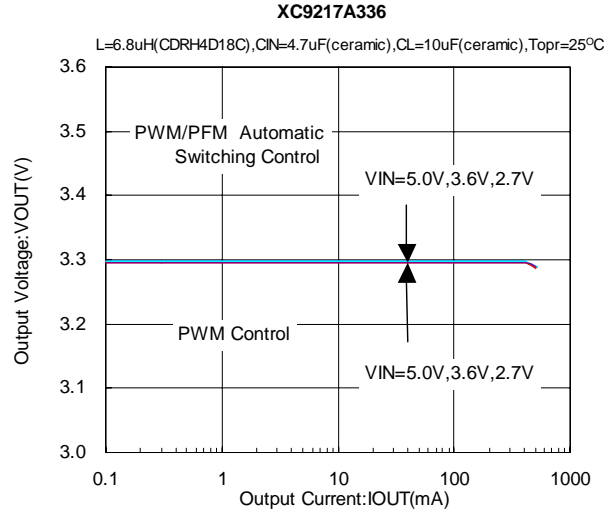
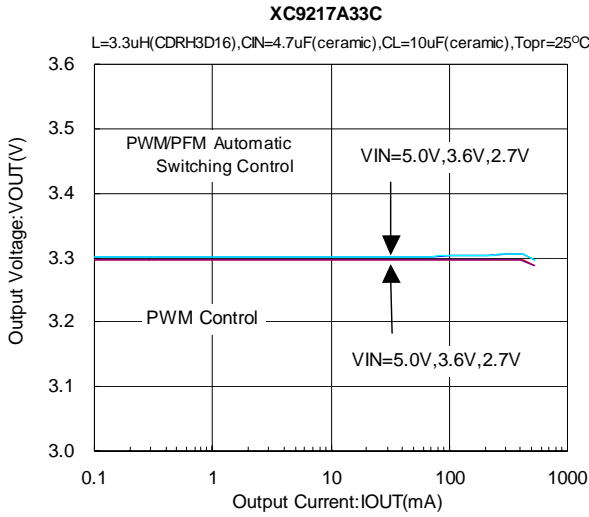

# XC9215/9216/9217 Series

500mA Synchronous Step-Down DC/DC Converters



## TYPICAL PERFORMANCE CHARACTERISTICS (Continued)

(4) Oscillation Frequency vs. Ambient Temperature

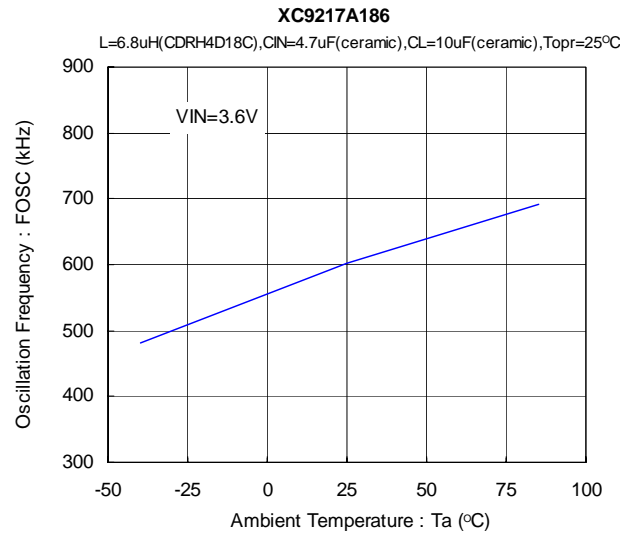
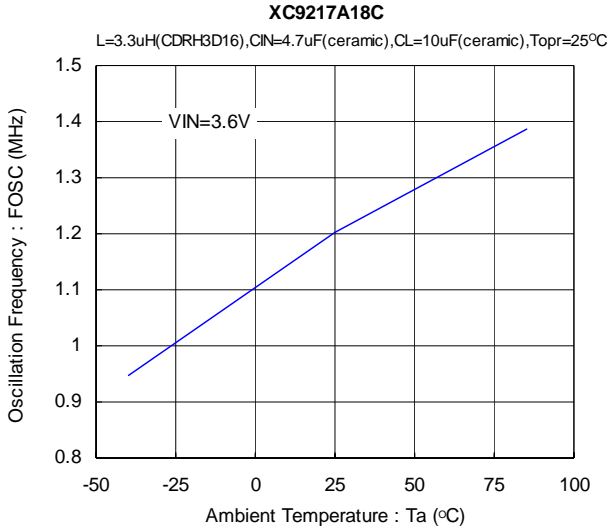

(5) Supply Current vs. Ambient Temperature

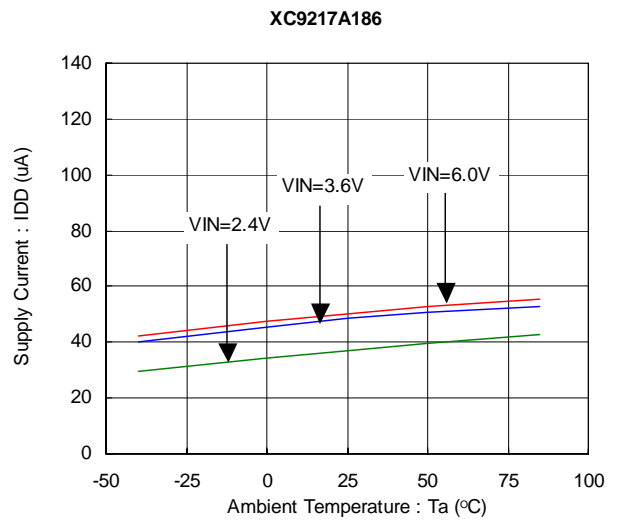
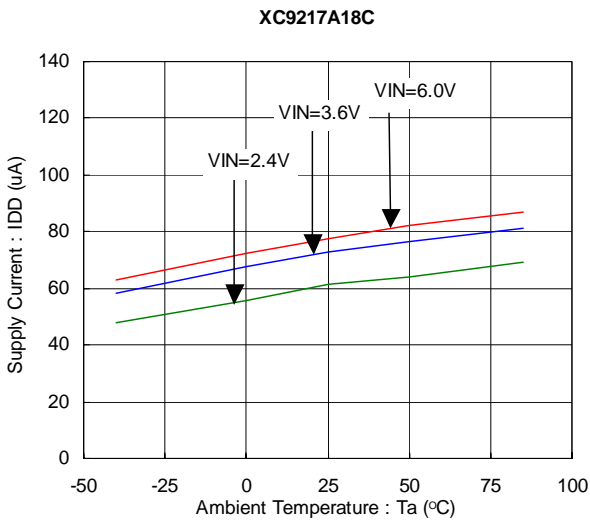

(6) Output Voltage vs. Ambient Temperature

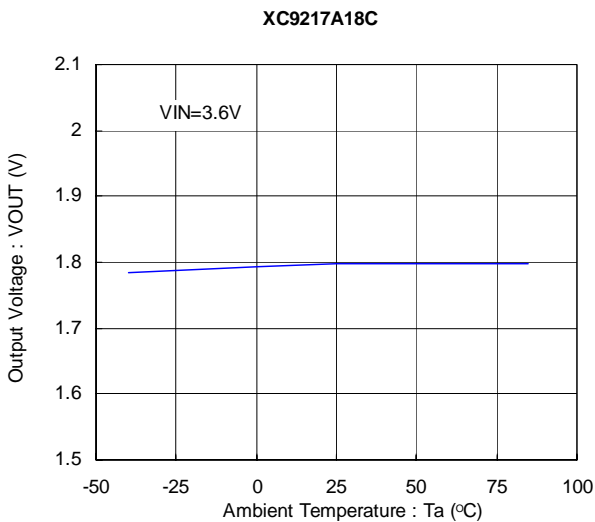

(7) U.V.L.O. Voltage vs. Ambient Temperature

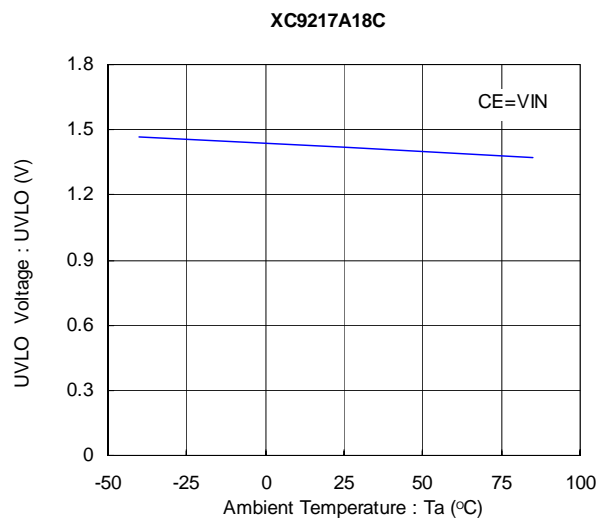

# XC9215/9216/9217 Series

500mA Synchronous Step-Down DC/DC Converters



## ■ TYPICAL PERFORMANCE CHARACTERISTICS (Continued)

(8) CE "H" "L" Voltage vs. Ambient Temperature

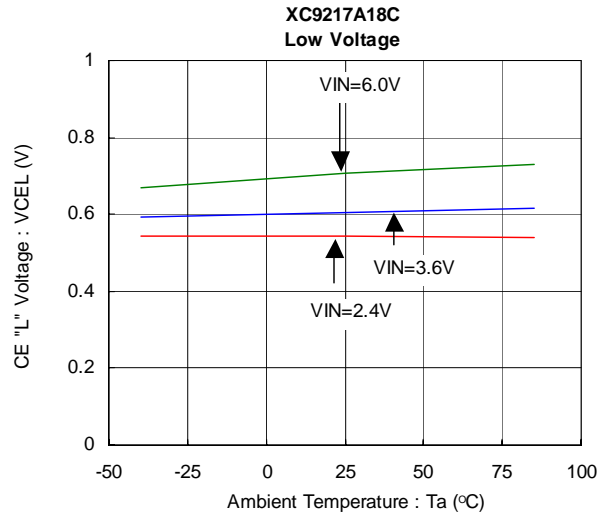
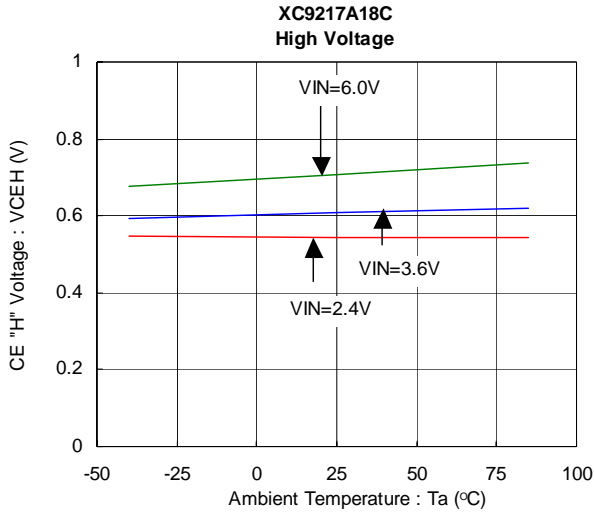

(9) Soft-start Time vs. Ambient Temperature

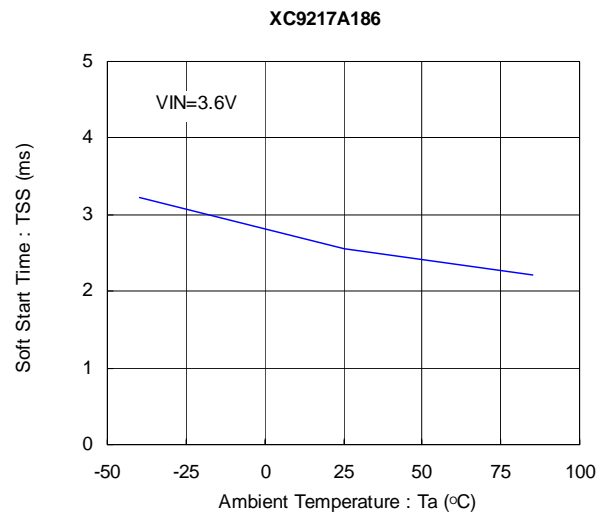
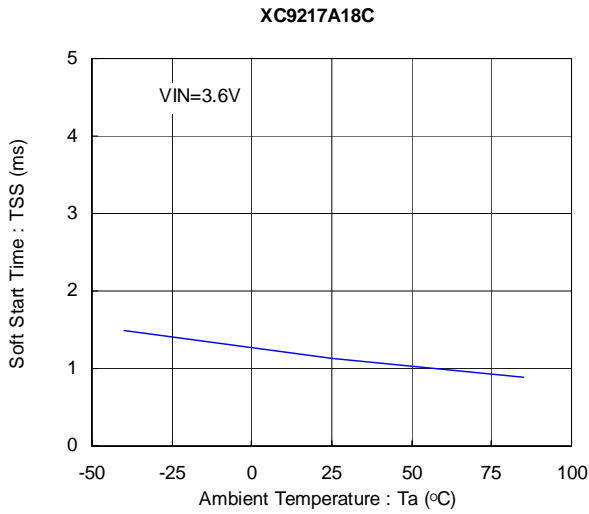

(10) "P-ch/N-ch" Driver ON Resistance vs. Ambient Temperature

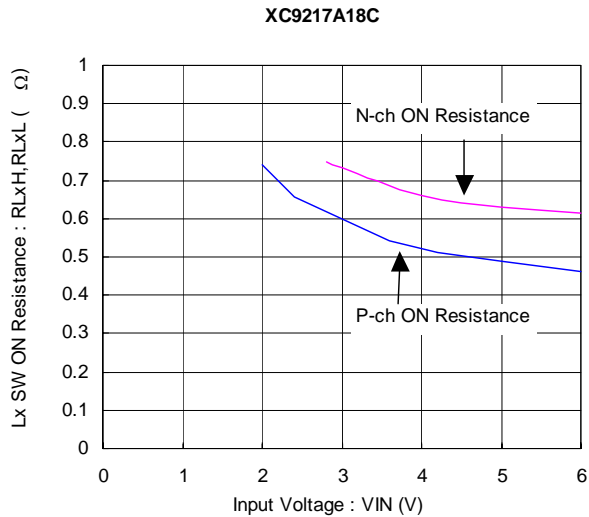

# XC9215/9216/9217 Series

500mA Synchronous Step-Down DC/DC Converters



## ■ TYPICAL PERFORMANCE CHARACTERISTICS (Continued)

(11) Load Transient Response Time

### XC9217A18C

L=3.3 $\mu$ H (CDRH3D16), CIN=4.7 $\mu$ F (ceramic), CL=10 $\mu$ F (ceramic), Topr=25°C  
VIN=3.6V, CE=VIN (PWM/PFM Automatic Switching Control)

IOUT=0.1mA  $\Rightarrow$  100mA

1ch : IOUT

2ch :  
VOUT=50mV/div

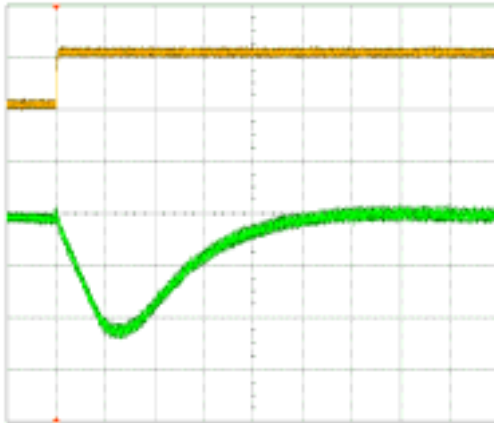

20 $\mu$ sec/div

IOUT=0.1mA  $\Rightarrow$  300mA

1ch : IOUT

2ch :  
VOUT=50mV/div

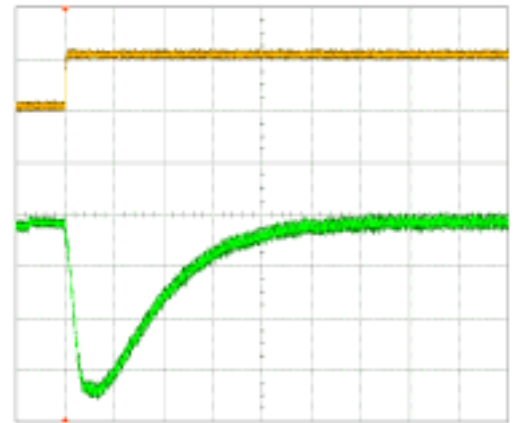

20 $\mu$ sec/div

IOUT=100mA  $\Rightarrow$  0.1mA

1ch : IOUT

2ch :  
VOUT=50mV/div

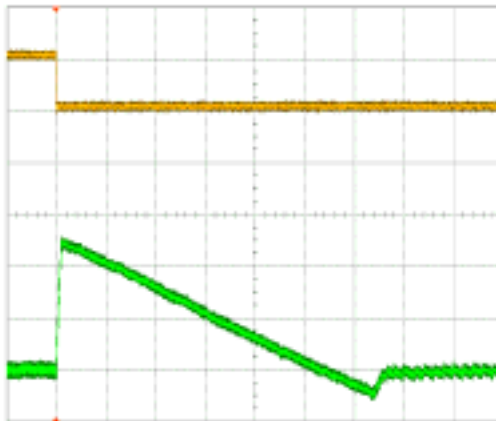

200 $\mu$ sec/div

IOUT=300mA  $\Rightarrow$  0.1mA

1ch : IOUT

2ch :  
VOUT=50mV/div

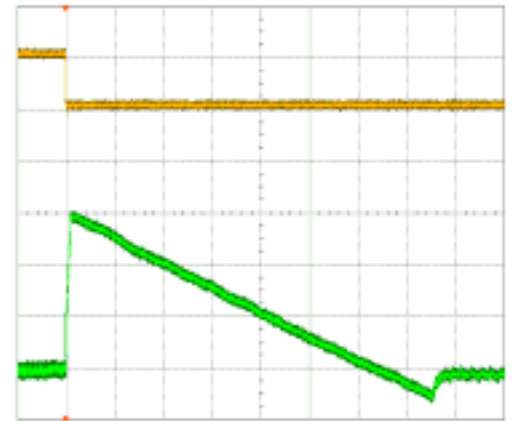

200 $\mu$ sec/div

# XC9215/9216/9217 Series

500mA Synchronous Step-Down DC/DC Converters



## ■ TYPICAL PERFORMANCE CHARACTERISTICS (Continued)

(11) Load Transient Response Time (Continued)

### XC9217A18C

$L=3.3\mu\text{H}$  (CDRH3D16),  $C_{\text{IN}}=4.7\mu\text{F}$  (ceramic),  $C_{\text{L}}=10\mu\text{F}$  (ceramic),  $T_{\text{opr}}=25^\circ\text{C}$   
 $V_{\text{IN}}=3.6\text{V}$ ,  $C_{\text{E}}=0.5 \times V_{\text{IN}}$  (PWM Control)

$I_{\text{OUT}}=0.1\text{mA} \Rightarrow 100\text{mA}$

1ch : IOUT

2ch :  
 $V_{\text{OUT}}=50\text{mV/div}$

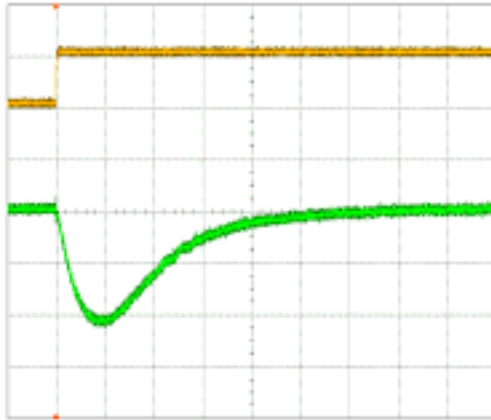

20µsec/div

$I_{\text{OUT}}=0.1\text{mA} \Rightarrow 300\text{mA}$

1ch : IOUT

2ch :  
 $V_{\text{OUT}}=50\text{mV/div}$

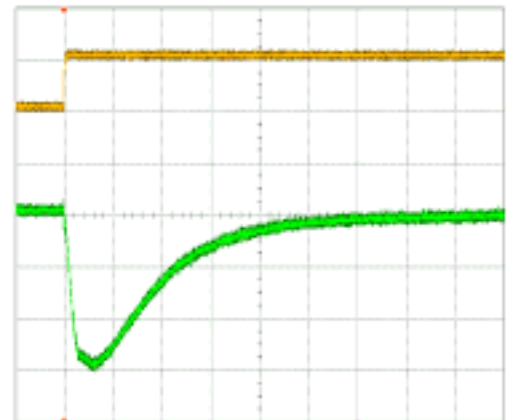

20µsec/div

$I_{\text{OUT}}=0.1\text{mA} \Rightarrow 100\text{mA}$

1ch : IOUT

2ch :  
 $V_{\text{OUT}}=50\text{mV/div}$

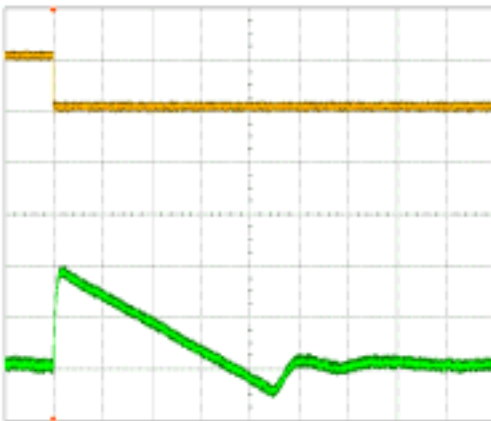

200µsec/div

$I_{\text{OUT}}=0.1\text{mA} \Rightarrow 300\text{mA}$

1ch : IOUT

2ch :  
 $V_{\text{OUT}}=50\text{mV/div}$

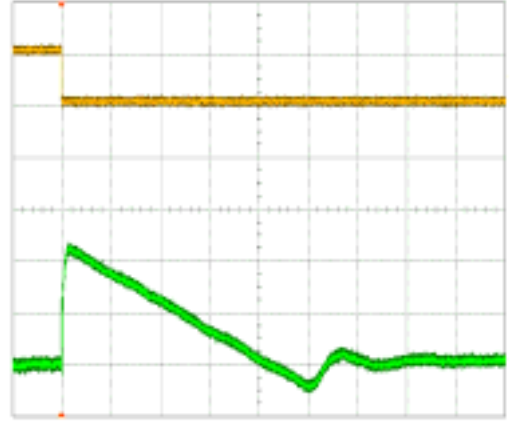

200µsec/div