

250mA Low Dropout Linear Voltage Regulator

● Features

- CMOS Low Power Consumption 4.0 μ A (TYP.)
- Dropout Voltage: 250mV at $I_{out} = 100\text{mA}$
- Output Current: more than 250mA
- Highly Accurate: $\pm 2\%$
- Current Limiter Circuit Built-In
- Output Voltage Range: 1.2V to 5.0V

● General Description

The RCR3135 series are precise, low power consumption, high voltage, positive voltage regulators manufactured using CMOS and laser trimming technologies. The series provides large currents with a significantly small dropout voltage. The RCR3135 series consists of a current limiter circuit, a driver transistor, a precision reference voltage and an error correction circuit.

The current limiter's feedback circuit also operates as a short protect for the output current limiter and the output pin. Output voltage can be set internally by laser trimming technologies. It is selectable in 100mV increments within a range of 2V to 5V. SOT23 packages are available.

● Applications

- Battery powered equipment
- Reference voltage sources
- Cameras, Video cameras
- Portable AV systems
- Mobile phones
- MP3
- Communication tools
- Portable games

● Package Information

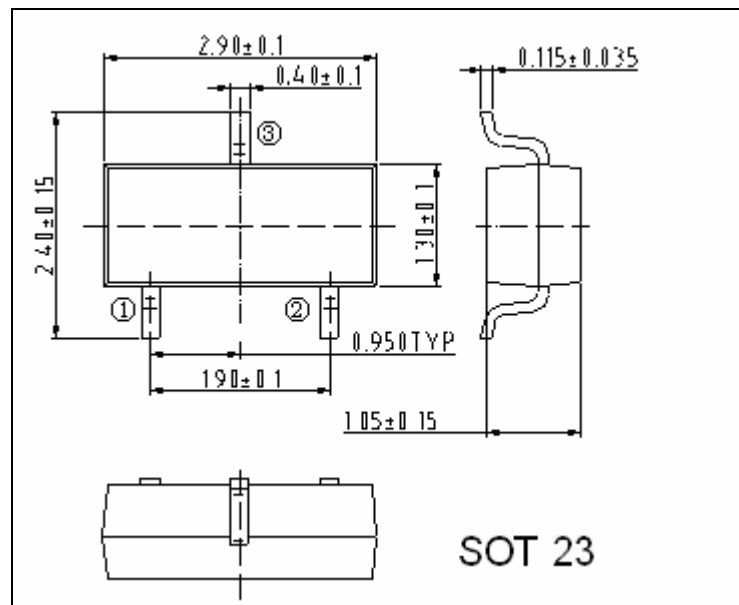

● **Pin Configurations**

Pin Name	SOT23
V _{IN}	3
V _{OUT}	2
GND	1

● **Functional Block Diagram**

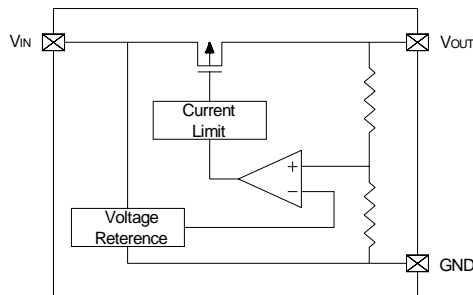

● **Ordering information**

RCR3135

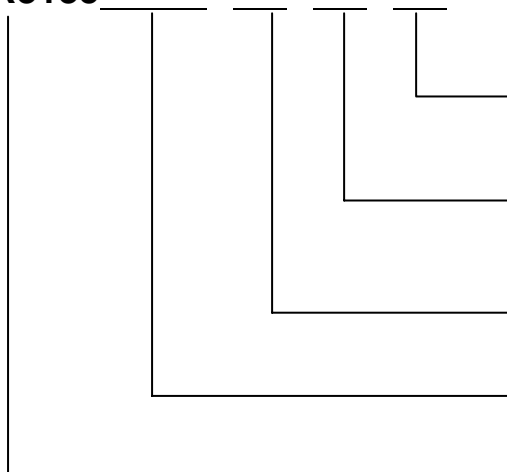

Device Orientation

R: Embossed Tape (Standard Feed)

L: Embossed Tape (Reverse Feed)

Package Type:

SI: SOT23

Accuracy:

2: within ± 2%

Output Voltage

...15=1.5V 20=2.0V 25=2.5V 33=3.3V 50=5.0V...

Indicate The Product Number

● **Absolute Maximum Ratings**

Parameter	Symbol	Ratings	Units
Input Voltage	V _{IN}	-0.3 to 9	V
Output Current	I _{OUT}	350	mA
Output Voltage	V _{OUT}	V _{SS} -0.3 to V _{IN} +0.3	V
Operating Ambient Temperature	T _{opr}	-40 to +125	
Storage Temperature	T _{stg}	-65 to +150	
Continuous Total Power Dissipation	P _D	SOT23 150	mW

● Electrical Characteristics

$V_{in}=V_{out}+1V$, $T_a=25$, $C_{in}=10\mu F, C_L=10\mu F$, unless otherwise specified.

Parameter	Symbol	Test Conditions	Min	Typ	Max	Units
Output Voltage	$V_{OUT(E)}$	$I_{OUT}=40mA$	0.98	$V_{OUT(T)}$	1.02	V
Maximum Output Current	I_{OUT}		250	--	--	mA
Load Regulation	V_{OUT}	1mA I_{OUT} 100mA	--	25	--	mV
Dropout Voltage	V_{drop1}	$I_{OUT}=80mA$	--	150	--	mV
	V_{drop2}	$I_{OUT}=160mA$	--	320	--	mV
Supply Current	I_{SS}	$V_{IN}=4.0V$	--	4.0	--	μA
Line Regulations	$\frac{V_{OUT}}{V_{OUT} * V_{IN}}$	$I_{OUT}=40mA$ $V_{OUT(T)}+1.0V$ V_{IN} 6V	--	0.01	0.3	%/V
Input Voltage	V_{IN}			--	9	V
Output Voltage Temperature Characteristics	$\frac{V_{OUT}}{Topr * V_{OUT}}$	$I_{OUT}=40mA$ -40 $Topr$ 85	--	± 100	--	ppm/

Note:

- $V_{OUT(T)}$ =Specified Output Voltage .
- $V_{OUT(E)}$ =Effective Output Voltage (i.e. the output voltage when " $V_{OUT(T)}+1.0V$ " is provided at the V_{IN} pin while maintaining a certain I_{OUT} value).
- $V_{drop} = \{V_{IN1} (\text{Note5}) - V_{OUT1} (\text{Note4})\}$
- V_{OUT1} = A voltage equal to 98% of the Output Voltage whenever an amply stabilized $I_{OUT} \{ V_{OUT(T)} + 1.0V \}$ is input.
- V_{IN1} = The Input Voltage when V_{OUT1} appears as Input Voltage is gradually decreased.
- Unless otherwise stated, $V_{IN} = V_{OUT(T)}+1.0V$

● Typical Application Circuit

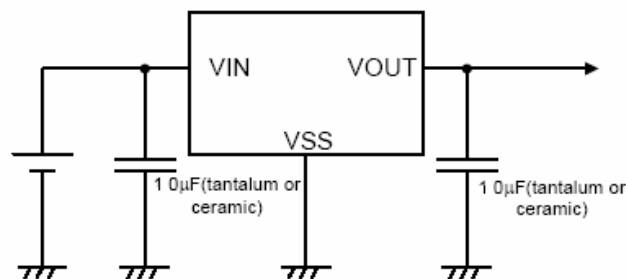

● Typical Performance Characteristics

1. Output Voltage vs. Output Current

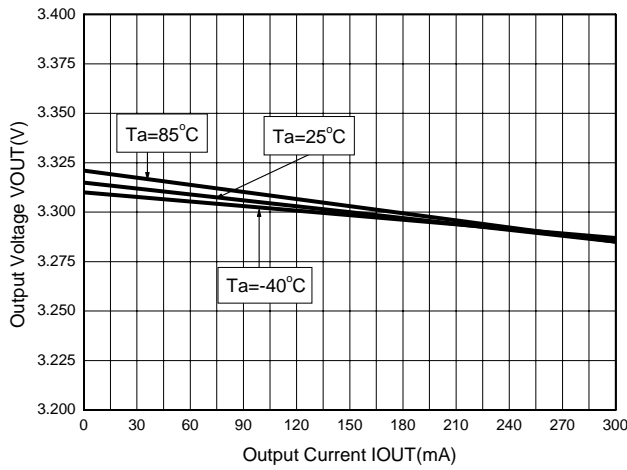

2. Output Voltage vs. Input Voltage

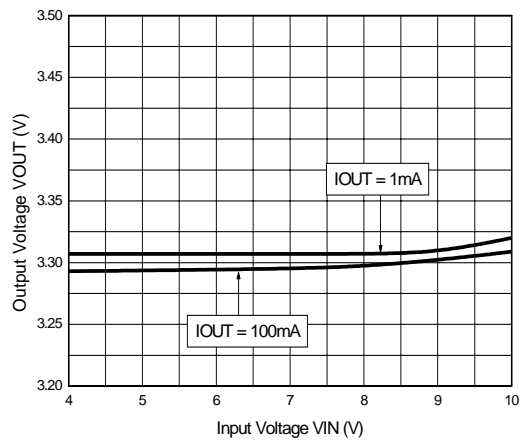
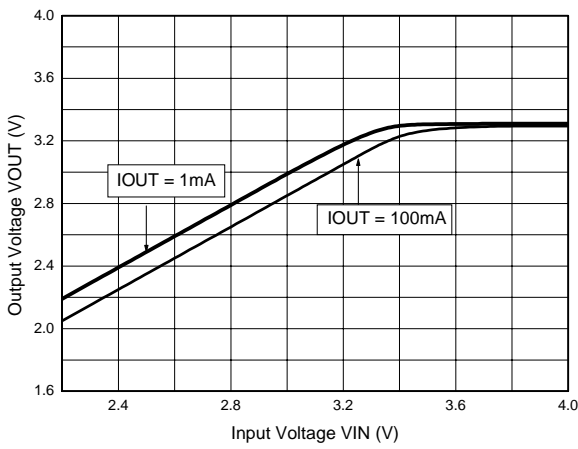

3. Dropout Voltage vs. Output Current

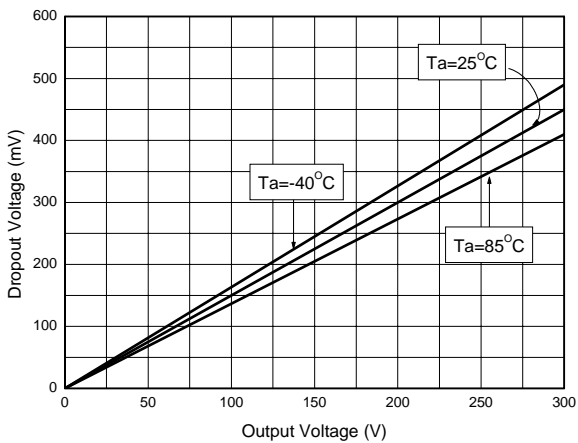

4. Supply Current vs. Input Voltage

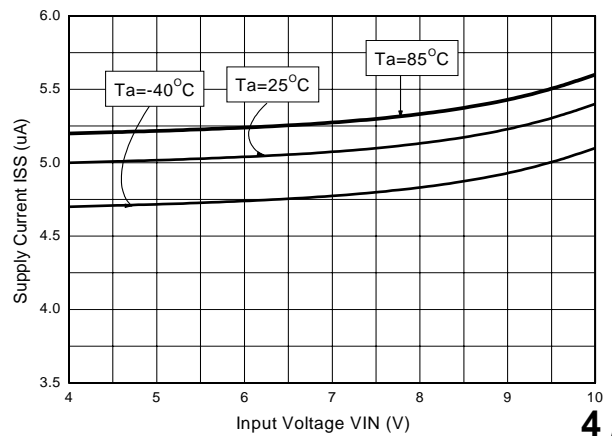

5. Output Voltage vs. Ambient Temperature

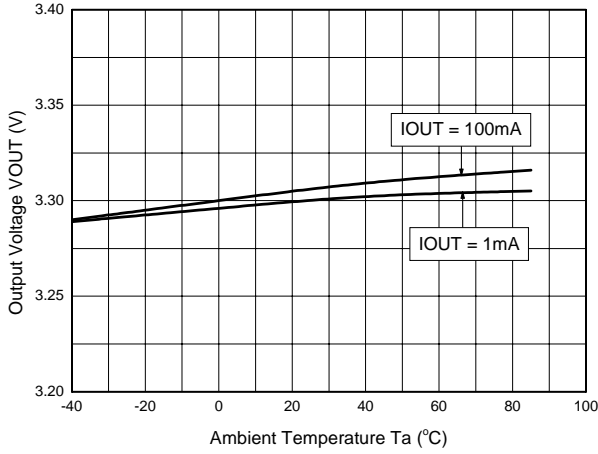

6. Supply Current vs. Ambient Temperature

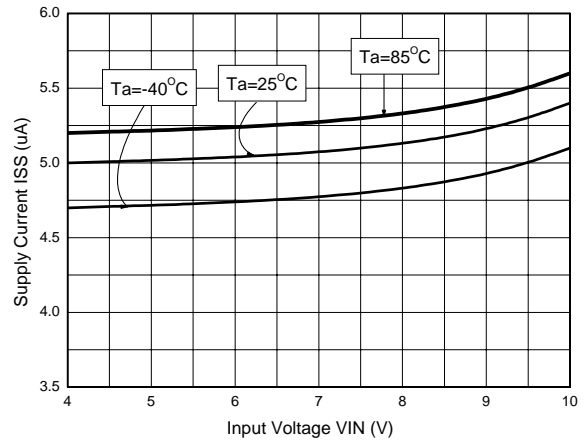

7. Input Transient Response

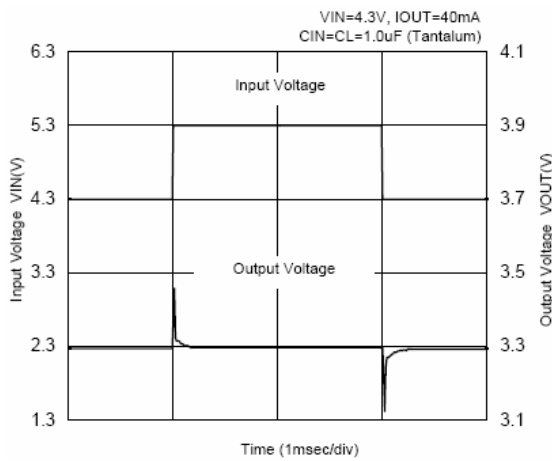

8. Load Transient Response

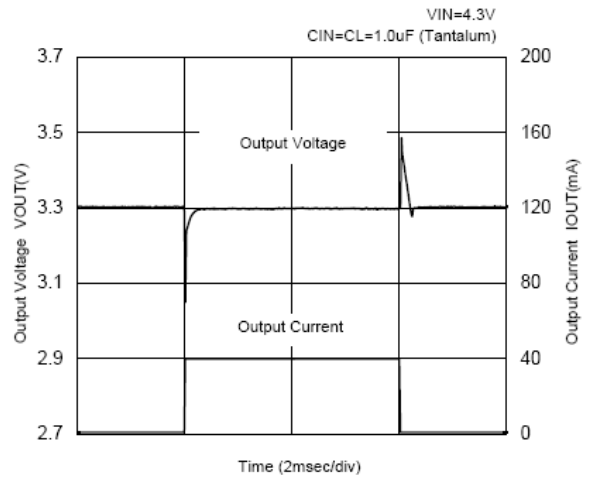

9. Ripple Rejection Rate

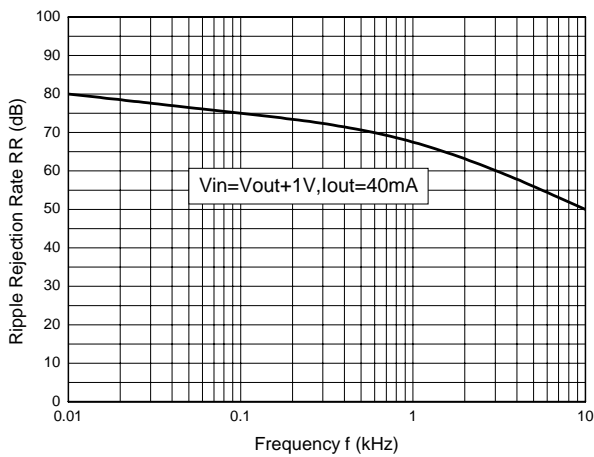

10. Output Noise Density

